

**Angst + Pfister – an engineering lead partner for the automotive industry**

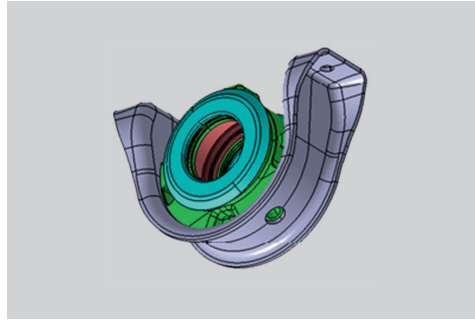

**Engineering services, development and certifications**

The Angst+Pfister Research&Development Department aims at providing advanced engineering services to the automotive industry. Leveraging on state-of-the-art technological engineering methods, our expert engineers design and develop seamless, reliable, and durable products and materials for the global market.

The Research&Development Department collaborates closely with customers on every phase of the project – from the first prototyping steps using Computer Aided Design (CAD), through Finite Element Method (FEM) to Virtual Design Engineering function checks are carried out on specific, ultra-modern testing benches. This procedure ensures exact measurement of product behavior both during and after manufacture. Each manufactured component receives a designated quality inspection according to a defined process flow chart.

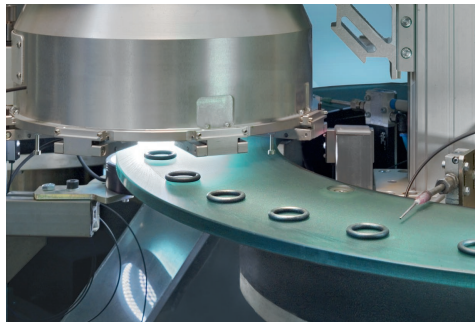

Across the whole value chain, Angst+Pfister is certified to ISO 9001, IATF 16949 and ISO 14001 standards. All our processes are based on an unrivalled quality management system that sets a new benchmark for the global automotive industry.



ISO 14001:2015



ISO 9001:2015



IATF 16949: 2016

**Most important OEM references**



**Most important automotive supply customers**



**Services from Angst + Pfister Group**

**Angst+Pfister – Your supply and solutions partner**

The Angst+Pfister Group is a leading international technical manufacturer and service provider for high-end industrial components. As a supply and solutions partner for engineering plastics, sealing, fluid handling, drive, and antivibration technology as well as

sensors, Angst+Pfister combines efficient logistics concept with comprehensive product application engineering services. Besides providing customer-specific parts, the Group offers a product range consisting of approximately 100,000 standard items.

**Our core product divisions**



**Switzerland**  
 Angst+Pfister AG  
 Thurgauerstrasse 66, Postfach, CH-8052 Zürich  
 Phone +41 (0)44 306 61 11  
 www.angst-pfister.com, ch@angst-pfister.com

Angst+Pfister SA  
 Chemin de la Papeterie 1, CH-1290 Versoix  
 Phone +41 (0)22 979 28 00  
 www.angst-pfister.com, ch@angst-pfister.com

**Germany**  
 Angst+Pfister GmbH  
 Siemensstraße 5, DE-70736 Fellbach  
 Phone +49 (0)711 48 999 2-0  
 www.angst-pfister.com, de@angst-pfister.com

**France**  
 Angst+Pfister SAS  
 Immeuble DELTAPARC  
 93, avenue des Nations, FR-93420 Villepinte  
 Phone +33 (0)1 48 63 20 80  
 www.angst-pfister.com, fr@angst-pfister.com

**Austria**  
 Angst+Pfister Ges.m.b.H.  
 Floridsdorfer Hauptstrasse 1/E, AT-1210 Wien  
 Phone +43 (0)1 258 46 01-0  
 www.angst-pfister.com, at@angst-pfister.com

**Italy**  
 Angst+Pfister S.p.A.  
 Via Montefeltro 4, IT-20156 Milano  
 Phone +39 02 82959 700  
 www.angst-pfister.com, it@angst-pfister.com

**Netherlands**  
 Angst+Pfister B.V.  
 Afrikaweg 40, NL-2713 AW Zoetermeer  
 Phone +31 (0)79 320 3700  
 www.angst-pfister.com, nl@angst-pfister.com

**Belgium**  
 Angst+Pfister N.V. S.A.  
 Bedrijvencentrum Waasland Industriepark-West 75  
 BE-9100 Sint-Niklaas  
 Phone +32 (0)3 778 0128  
 www.angst-pfister.com, be@angst-pfister.com

**China**  
 Angst+Pfister Engineering Technology (Shanghai) Co., Ltd.  
 Rm 1803-1805, West Tower,  
 Zhong Rong Hengrui Building  
 No. 560 Zhangyang Road, CN-Shanghai 200122  
 Phone +86 21 5169 5005  
 www.angst-pfister.com, cn@angst-pfister.com

**Turkey**  
 Angst Pfister Advanced Technical Solutions A.Ş.  
 Akçalar Sanayi Bölgesi Kale Cd., No: 10,  
 TR-16225 Nilüfer/Bursa  
 Phone +90 224 280 69 00  
 www.angst-pfister.com/ats, ats@angst-pfister.com

**Poland**  
 Angst+Pfister Sp. z o.o.  
 ul. Komorowicka 260, PL-43-346 Bielsko-Biala  
 Phone +48 33 443 29 70  
 www.angst-pfister.com, pl@angst-pfister.com



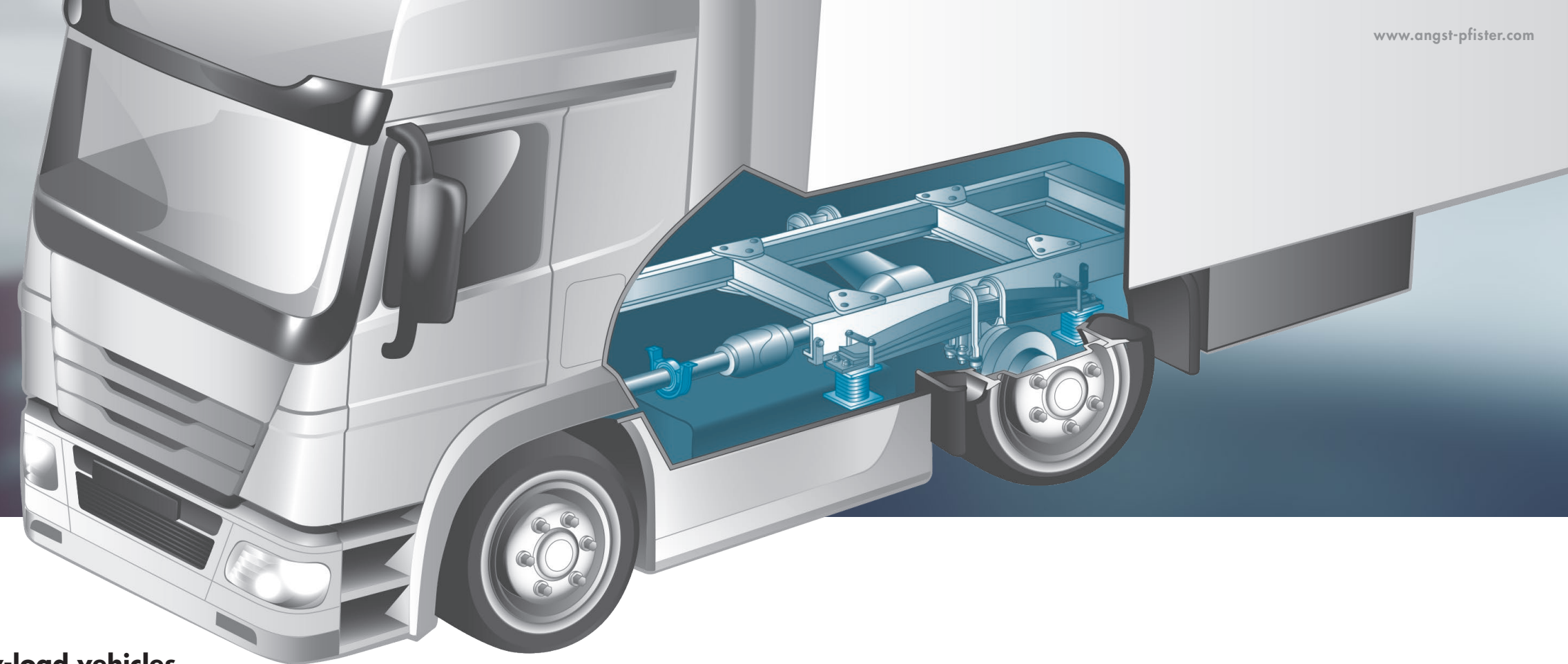
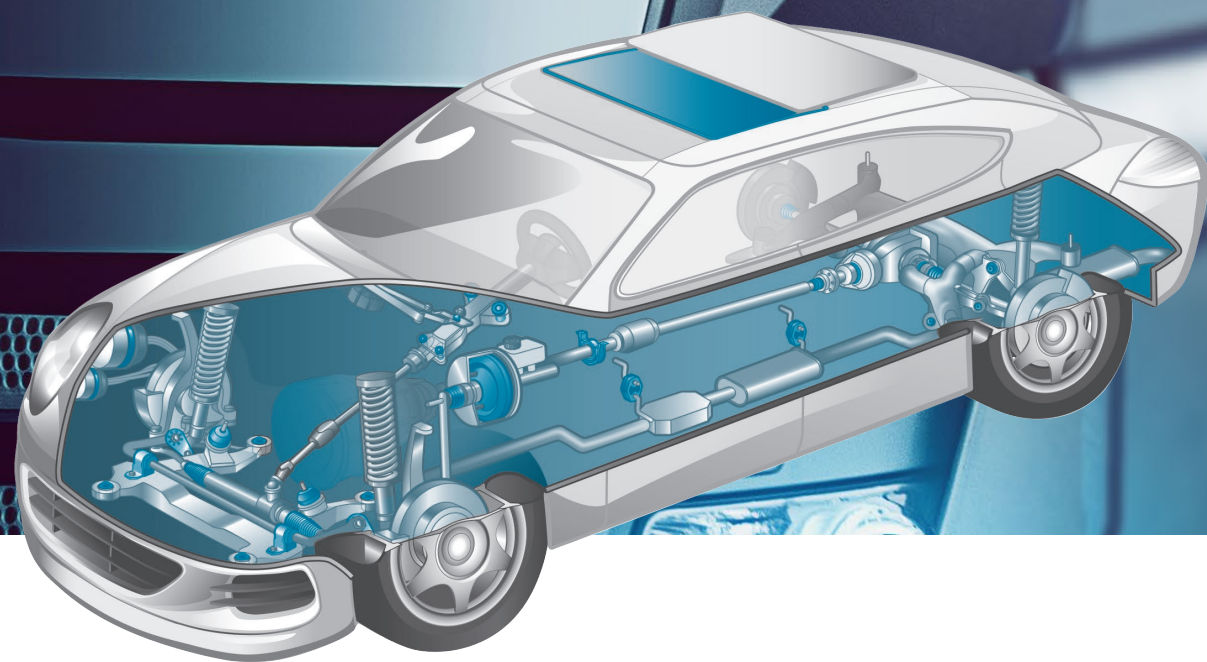

### Angst + Pfister Group Technology: at the forefront of automotive innovation

#### High-performance solutions and a truly global presence

With dedicated production facilities located in one of the world's largest automotive manufacturing zones, Angst+Pfister is designed to be a full-service provider. Collaborating closely with the automotive industry, the company develops innovative antivibration and sealing solutions. This approach produces high-performance components for passenger cars and commercial vehicles all over the world.

Utilizing state-of-the-art engineering equipment and testing methods, Angst+Pfister is also a premium design partner: Efficient prototyping, streamlined series production and global supply chain solutions ensure new products are quickly brought to market.

### Angst + Pfister: pioneering concepts for commercial and heavy-load vehicles











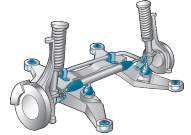



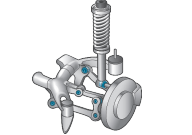





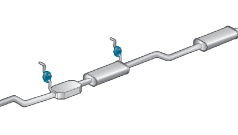



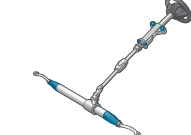



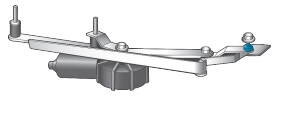



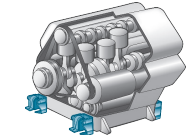





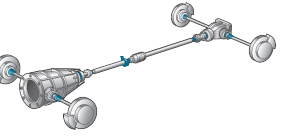

#### Innovative solutions for trucks, construction and agricultural vehicles

The construction, agricultural and transport industries are voicing new demands in respect of the efficiency and robustness of commercial vehicles. These industries see themselves confronted by commercially aggressive events in the world market – with cost pressures constantly increasing.

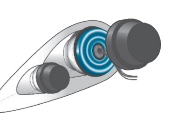
In collaboration with their customers, Angst+Pfister is developing innovative customized solutions for commercial and heavy-load vehicles, which not only satisfy the latest trends, but also set new standards in terms of convenience, energy efficiency and durability.

From vibration-optimized cabin mounts and cab suspensions, through to friction-optimized cassette seals and optimized suspensions for cardan shafts: Angst+Pfister provides you with a competitive advantage – thanks to efficient prototyping, own test laboratories, flexible high-quality production and highly competent on-site engineers.

### Components for commercial cars & heavy-load vehicles

Axle modules	Suspension strut	Exhaust and mass damper	Steering	Chassis	Engine
  Steering bellows  Subframe bushing  Stabilizer bar bushing	  Suspension bushing  Rubber bolster  Control arm bushing  Control arm bushing  Suspension bushing	  Exhaust hanger  Mass damper  Exhaust top mount	  Steering bellows  Steering system bushing  Steering axle bush	  Wiper motor mount  Elastomeric profile  Leaf spring  Suspension bushing	  Engine and transmission mounts  Torque-support  Clamp bracket  Transmission mount
 Diaphragm  Actuator seal  Excluder	  Radial shaft seal and static seal  Cardan shaft hanger  Bellows	  Headlamp seal  Molded seal	 Flat gasket  Radial shaft seal and static seal  Torque bracket  Rubber damping element		