

Rotating Seals

TECHNICAL CATALOGUE





Table of Contents

1.	Rotary Dynamic Seals	04
2.	Elastomer Lip Radial Shaft Seal Concept	06
3.	Static Sealing Conditions	08
4.	Dynamic Sealing Conditions	09
5.	The Dynamic Sealing Mechanism	10
	a. Load Support Mechanism	10
	b. Reverse Pumping Mechanism	12
6.	PTFE Radial Shaft Seal Concept	15
7.	Seal Types	20
8.	Garter Spring	26
9.	Shaft	28
10.	Housing	37
11.	Friction, Drag Torque, Power Absorption	39
12.	Simulation	42
13.	Testing	43
14.	Storage	48
15.	Installation	48
16.	Order Template	52
17.	Disclaimer	53



1. Rotary Dynamic Seals

Rotary Dynamic Seals are used in fluid machines containing rotating parts to prevent leakage of fluid (either liquid or gaseous) out of the machine, intrusion of contaminants into the machine, and leakage of fluid between chambers inside the machine.

Their sealing function grants a reliable operation of the machines and protects the environment from harmful and undesired emissions. Rotary Dynamic Seals are made of one or more

interfaces between a rotating and a stationary surface.

For this reason, they're considered tribological components and they seal the space between a shaft and a housing.

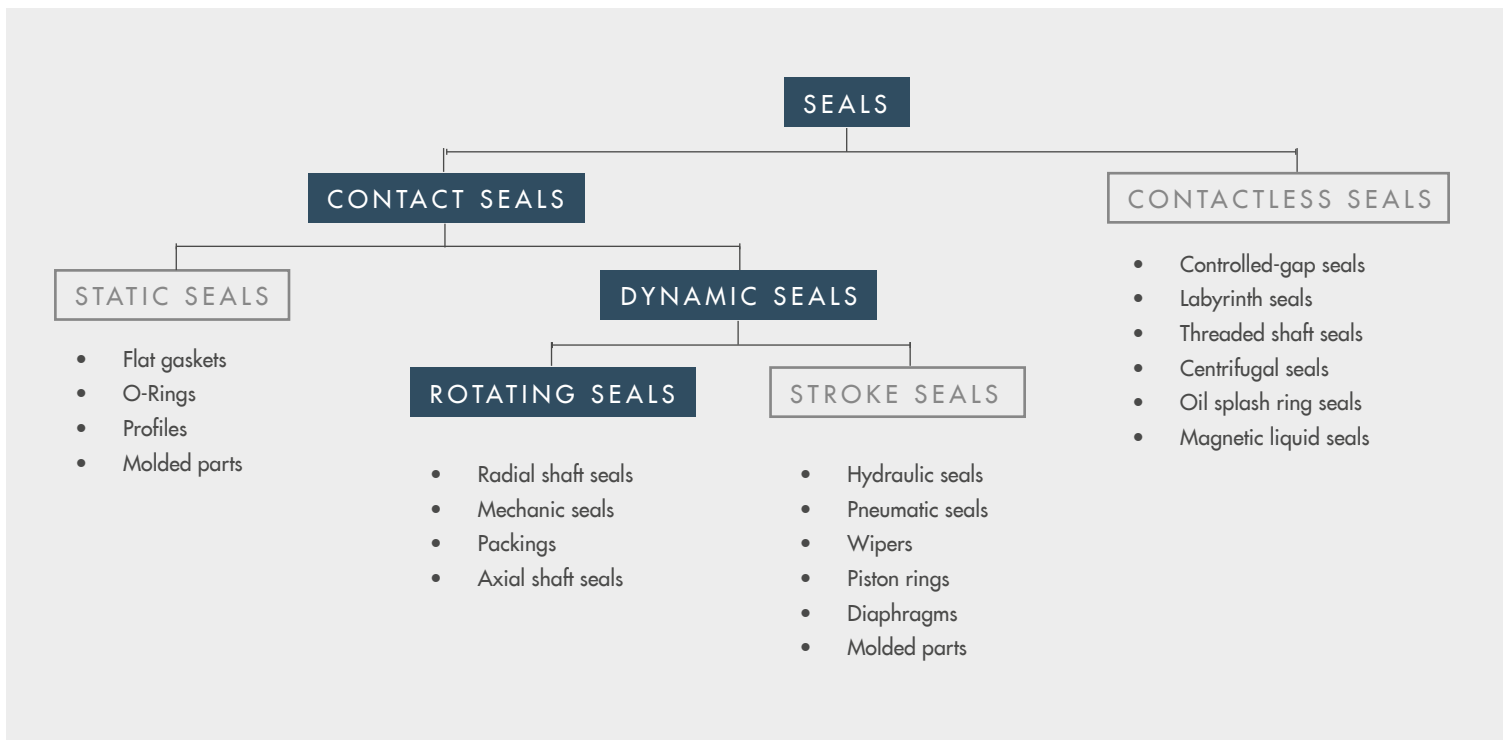

Exhibit 1 – Seal Type Nomenclature



Since they're produced in large volumes at a relatively low cost, the most popular Rotary Dynamic Seals are the Elastomer Lip type Radial Shaft Seals.

Elastomer Lip Radial Shaft Seals are therefore utilized in many low-pressure applications in the automotive industry, domestic appliances industry, automation industry, process industry, agriculture machines, construction equipment, and many others.

The Norms that standardize the types and sizes of the Elastomer Lip Radial Shaft Seals are DIN 3760 and ISO 6194; the most popular types are the so-called "A" type (single Seal Lip) and "AS" type (Seal Lip and supplementary Dust Lip) as shown in sectional view in Exhibit 2.

NBR (Nitrile Butadiene Rubber) is the most widely used elastomer compound to produce the Radial Shaft Seals because of the relatively low cost and of the medium operating temperature range (-40°C / +100°C. FKM (Fluorocarbon Rubber) is popular for

higher temperature ranges (-40°C / +200°C). NBR and FKM are the most commonly used compounds for Elastomer Lip Radial Shaft Seals. Additional types of compounds like HNBR (Hydrogenated NBR), ACM (Acrylic Rubber), CR (Chloroprene Rubber), EPDM (Ethylene Propylene Diene Monomer Rubber), VMQ (Vinyl Methyl Silicone Rubber) are used for specific purposes depending on the related chemical resistance, physical properties, and temperature range.

Our Compound and Material Technical Guide provides useful information for the variety and features of the different compounds.

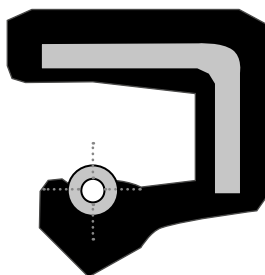

A-type Single Lip Seal

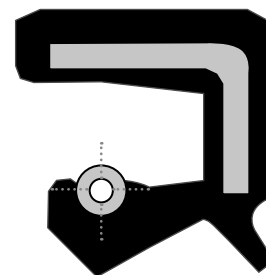

AS-type Seal with supplementary Dust Lip

Exhibit 2 – Cut view of the cross section of an A-type and an AS-type Elastomer Lip Radial Shaft Seal

2. Elastomer Lip Radial Shaft Seal Concept

The sectional view of a typical Elastomer Lip Radial Shaft Seal and how it is used on the fixture is shown in Fig. 3.

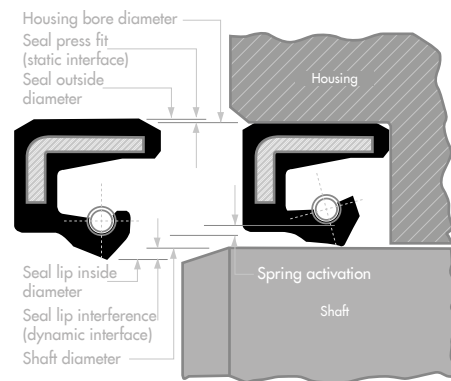

Exhibit 3 – Sectional view of an Elastomer Lip Radial Shaft Seal – free on the left, installed on the right

Three main parts make up the Radial Shaft Seal:

- **Metal Insert** (to provide the mechanical solidity)
- **Rubber Diaphragm**, chemically bonded to the metal insert (it provides the casing of the outer surface, the Primary Sealing Lip, and the Dust Lip that is optionally available but not essential for the fluid sealing, and the spring lodging)

- **Garter Spring** (it increases the radial force of the sealing lip on the shaft surface to overcome compression set and wear of the lip, off-set between shaft and housing axes, and dynamic run-out)

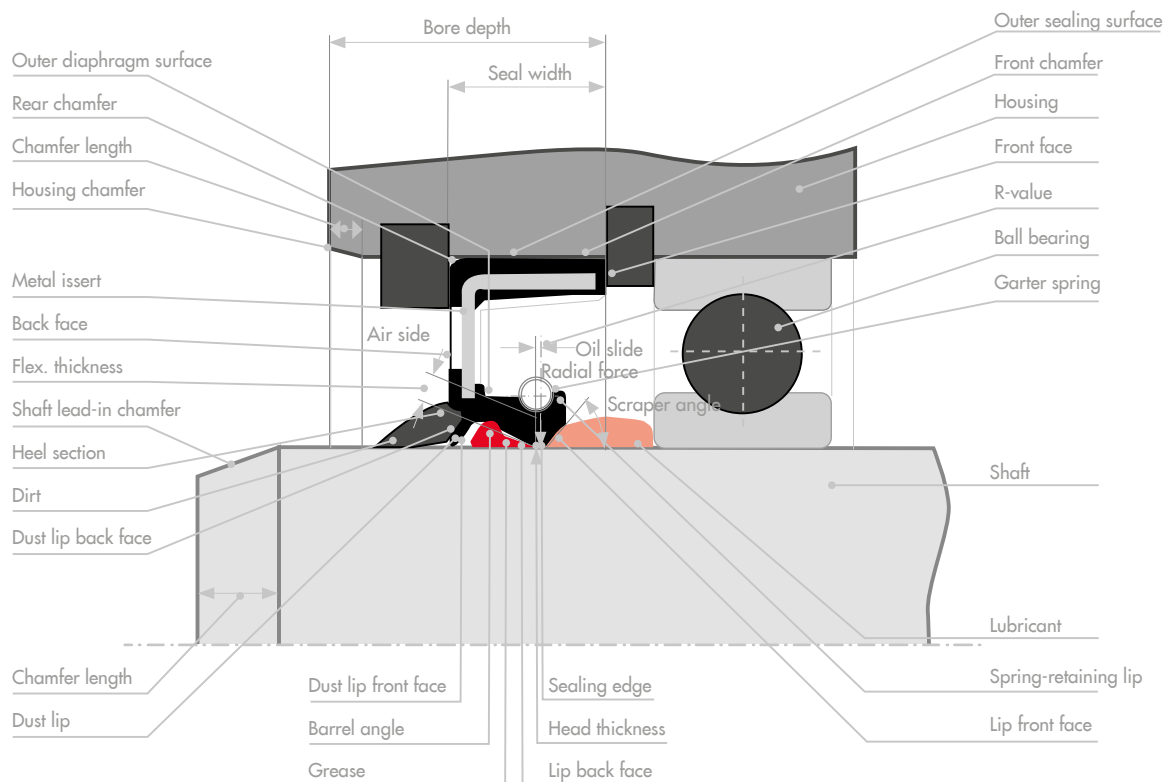

Exhibit 4 – The geometrical details of the Radial Shaft Seal; Nomenclature of the Elastomer Lip Radial Shaft Seal

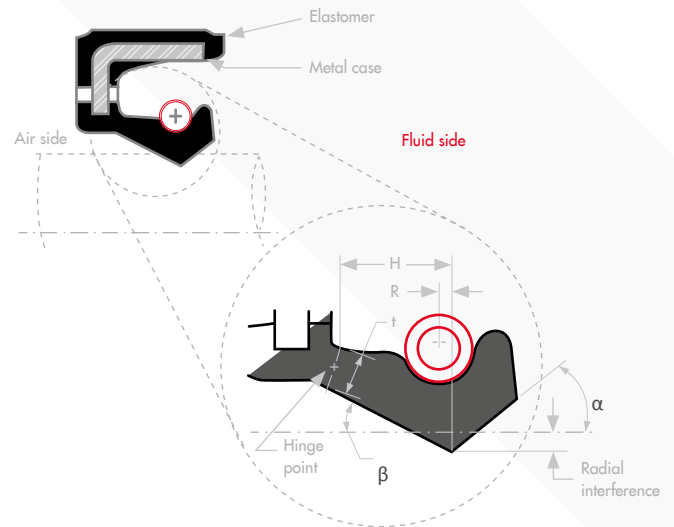

Exhibit 5 – Nomenclature of the Elastomer Sealing Lip. R =distance between lip axis and spring axis, H =lip length, t =thickness of bending plane, α =lip internal angle – fluid side, β =lip external angle – air side

The fluid Sealing Function is performed by the Sealing Lip; the macrogeometry of the Sealing Lip is shown in Exhibit 5

In order to effectively fulfill the sealing function, two essential conditions must be met for the macrogeometry of the sealing lip

- $R > 0$ (spring axis closer to the air side than the lip axis)
- $\alpha > \beta$ (normally $\alpha = 30^\circ - 70^\circ$, and $\beta = 12^\circ - 35^\circ$)

After installation of the Radial Shaft Seal, the Garter Spring gets activated by the hoop enlargement of the Seal Lip inner diameter caused by the interference with the Shaft (Shaft diameter > Seal Lip inner free diameter – see Exhibit 6).

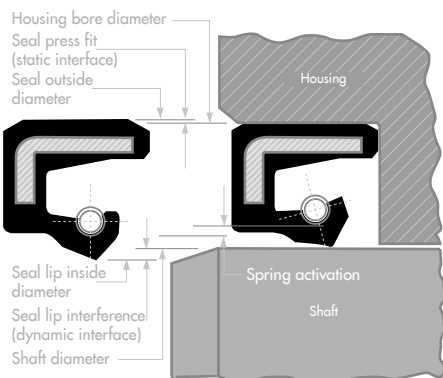

Exhibit 6 – Garter Spring activation after the Radial Shaft Seal installation

The apex of the sealing lip exerts a radial force on the surface of the shaft due to the superposition of three effects: the rubber beam deflection force, the rubber hoop force of the elastomer due to the Seal Lip interference, and the Garter Spring load.

This Total Radial Force deforms the Seal Lip Apex against the Shaft surface and determines a Contact Width of the initial order of 0.1 mm as shown in Exhibit 7. The contact width along the circumference of the shaft defines the Sealing Region in which both static and dynamic sealing is performed by the Seal Lip.

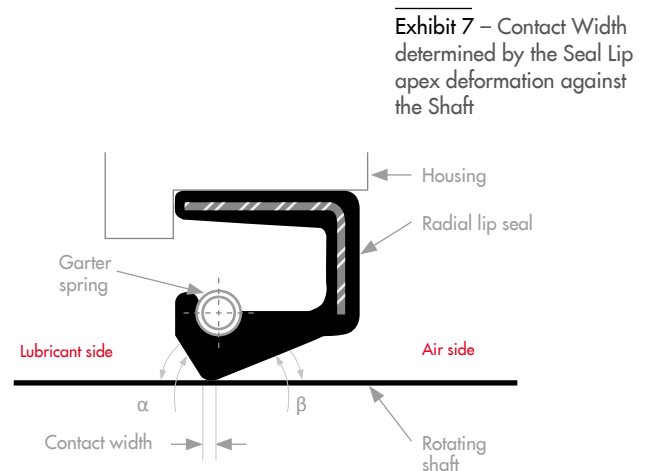

Exhibit 7 – Contact Width determined by the Seal Lip apex deformation against the Shaft



The exerted force by the Seal Lip Apex against the Shaft surface generates a Radial Static Contact Pressure by the Seal Lip on the Sealing Region (area determined by the contact width times the shaft

surface circumferential length) and its distribution depends on the Seal Lip Apex macrogeometry (see Exhibit 8).

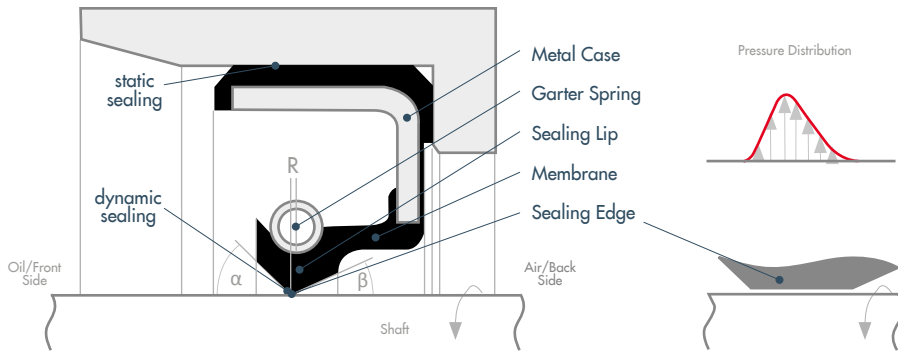

Exhibit 8 – Radial Static Contact Pressure Distribution under the Sealing Edge contact width

3. Static Sealing Condition

The Static Pressure Distribution under the Lip apex performs the Fluid Sealing under Static Conditions on the shaft side. Fluid sealing under static conditions must also be provided by the elastomer, which is located on the outside diameter of the rotary shaft seal. In these cases the rubber liner has an interference with the bore diameter. Some special designs of rotary shaft seals generate the static sealing on the outer diameter by metal to metal surface contact. (See also Chapter 7)

4. Dynamic Sealing Condition

It is observed and verified, initially with indirect evidence (friction measurement) and then with direct evidence (film thickness measurement), that a continuous film of the liquid to be sealed separates under dynamic-steady conditions the Lip from the Shaft surface.

Since the lubricating liquid film between the Shaft surface and the Lip surface is continuous, to prevent

the leakage in dynamic operating conditions there must be a Sealing Mechanism (see Exhibit 9).

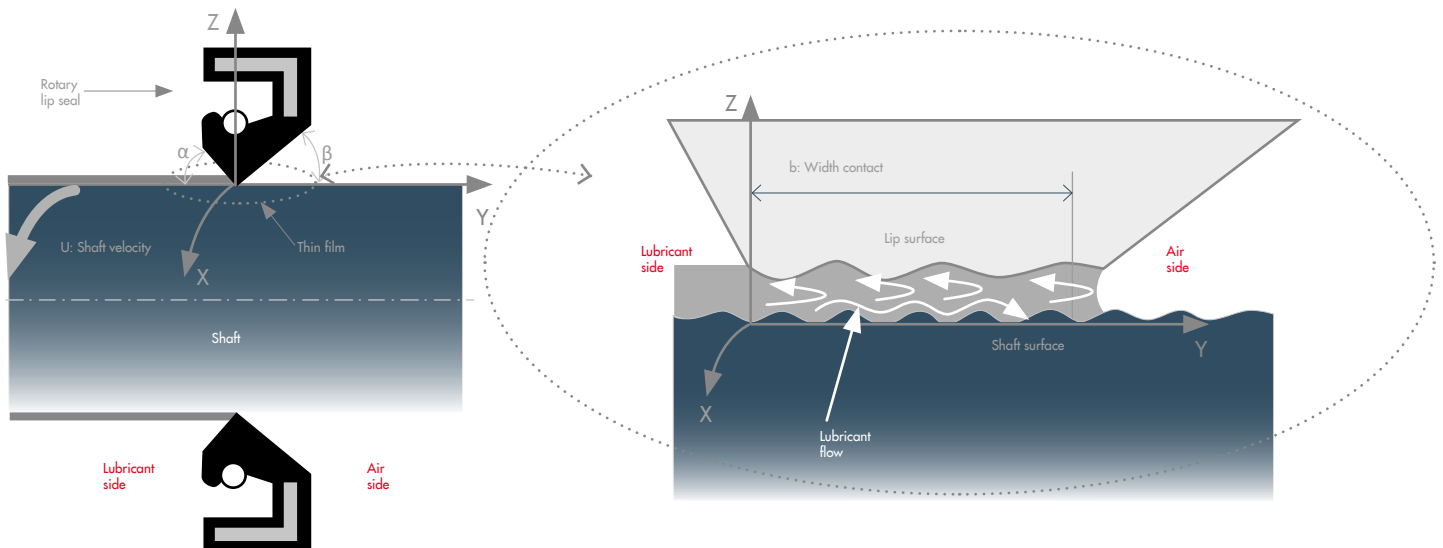

Exhibit 9 – Under dynamic-steady conditions, a lubricant film separates the Lip Seal from the Shaft Surface. The arrows show the effect of the reverse pumping that produces a flow back to the oil side as later shown in Exhibit 16.

Two physical combined phenomena must be explained:

- Load Support Mechanism that produces elevated pressures in the film which causes the Lip to lift off the Shaft and which maintains the integrity of the film.
- Sealing Mechanism that prevents the fluid to pass through and to leak out.

5. Dynamic Sealing Mechanism

5.a Load Support Mechanism

For a correct comprehension of the mentioned phenomena, it is necessary to deepen the details of the sequence of effects that occur on the mating surfaces of the Seal Lip and of the Shaft within the Sealing Region from the assembling of the new Radial Shaft Seal on the Shaft to the achievement of dynamic steady-state operating conditions.

Three steps can be distinguished: Break-In, Run-In and Dynamic Steady-State (see Exhibit 10).

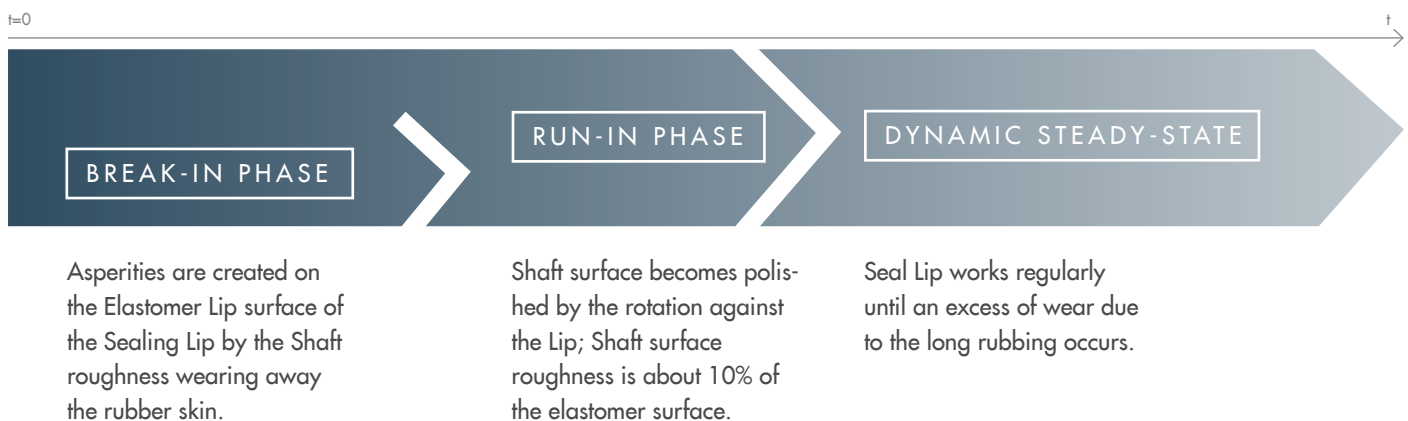

Exhibit 10 – Sequence of occurrences between the assembling and the steady working operation of a Radial Shaft Seal. “ $t=0$ ” indicates the starting time of rotation of the new seal; “ t ” is the timeline.

The Break-In period is the transient time when the seal is subjected to dynamic condition after the assembling; during this period, the lip gets conditioned by a preferential wear process that develops the Lip microgeometry by preferential way due to the heterogeneity of the elastomer. During the Break-In Phase, there are two major factors affecting the Lip sealing surface:

- Formation of Asperities on the elastomer surface of the Sealing Region during which near surface filler particles and filler particle agglomerates are worn away.
- Deformation of the Sealing Region surface circumferentially along the rotation direction

The Sealing Zone has initially the width of nearly 0.1mm and after the Break-In period it increases to 0.2-0.3mm due to the wear effect.

Radial shaft seal

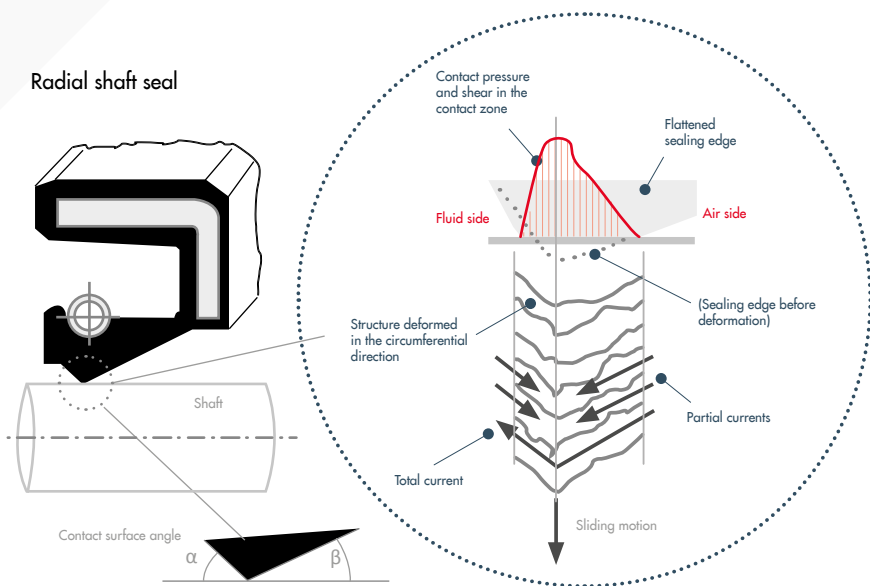

Exhibit 11 – The sliding motion produces the deformation of the Sealing Region surface in the circumferential direction.

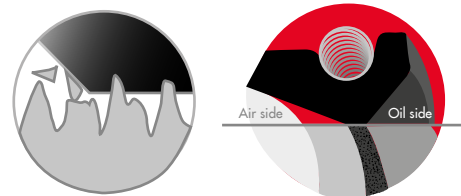

Exhibit 12 – Polishing action (left side) and Polishing effect (right side) of the mating Shaft surface

During the Run-In Phase (that includes the Break-In Phase too), the Shaft surface gets polished by the rubbing against the Lip elastomer. The effect is to eliminate the highest peaks of metal asperities, as shown in Exhibit 12.

To explain the Load Support Mechanism, the surface roughness of the elastomer Lip and of the metal Shaft must be considered; on both sides there are asperities and cavities.

The Lip asperities in combination with the Shaft rotation act as micro slider bearings and cause the Lip to lift off the Shaft; eventually the Lip completely lifts the Shaft and a continuous fluid film is established.

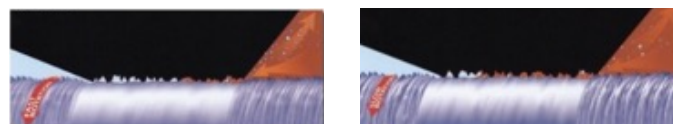

Exhibit 13 – Progressive establishment of the lubricant film by wedging. In combination with the Shaft rotation, asperities act as micro slider bearings and cause the Lip to lift off the Shaft; the Lip lifts completely off the Shaft and a continuous fluid film is established.

After the Break-In Phase, when the Seal Lip is conditioned (formation of asperities and cavities is completed), under steady-state rotating conditions, the asperities act again as micro slider bearings and produce the elevated pressures in the film that cause the Lip to lift off the Shaft and to maintain the integrity of the film that has a thickness of the order of $1 \mu\text{m}$.

The formation of the lubricant film generates the lift-off of the Sealing Lip Apex from the Shaft surface, reduces the friction, minimizes the wear, and dissipates the local heat due to friction during the operating conditions (see Exhibit 13).

Another contribution to the load formation can be generated by the so-called “hydrodynamic seals” (as will be explained in more detail later, all the Radial Shaft Lip Seals perform hydrodynamically) that show on the Lip surface some molded geometric helix, sinusoidal wave, or straight ribs for the purpose of enhancing the hydrodynamic pumping effect to improve the sealing performance at high tangential speed. Such ribs obviously determine additional cavities on the Seal Lip Apex which are filled with lubricant subject to hydrodynamic pressure.

5.b Reverse Pumping Mechanism

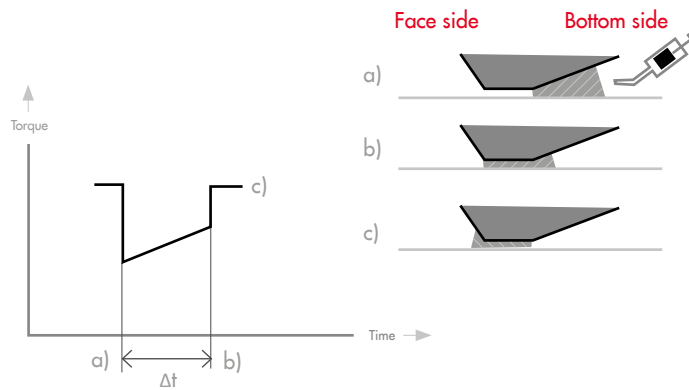

Exhibit 14 – Reverse pumping effect. For a Radial Lip Seal operating at uniform rotation in the dry condition, when the air side of the seal lip is flooded with some lubricating oil, the drag torque decreases until the oil on the lubricant side is drained. This is the evidence of the reverse pumping effect produced by the Seal Lip in steady dynamic conditions. The flow rate equals the volume of flooded oil divided by the time to get it drained.

Having clarified the Load Support Mechanism, now the Dynamic Sealing Mechanism must be analyzed.

Exhibit 11 shows that, during relative rotation between the Shaft and the Elastomer Seal Lip, the Lip gets deformed due to circumferential shear along the direction of rotation with the peak of deformation in the apex. The wearing process during the Break-In Phase has produced asperities and cavities along some preferential direction defined by the stress and the compound composition. On the Lip surface the undulations corresponding to the asperity lines may appear with a wave pattern.

During rotation, the wave asperities act like viscous pumps which produce reverse pumping from the air side of the seal to the liquid side, opposing and preventing natural leakage flow.

For an effective seal, it is verified that, if some fluid is flooding the Seal Lip from the air side, the fluid is pumped towards the lubricant side; this phenomenon is called reverse pumping (see Exhibit 15)

So, for an effective seal, the Dynamic Sealing Mechanism is the Reverse Pumping Mechanism that

must have a rate to balance the natural leakage of the seal when the lubricant film is maintained (see Exhibit 15).

The Seal Lip must be analyzed under the perspective of its microgeometry and of its macrogeometry. The roughness pattern of the Lip Seal surface in the Sealing Region is a key factor for the seal performance; a successful Seal needs a large number of asperities (related to the surface roughness) or micro-undulations (made for the purpose).

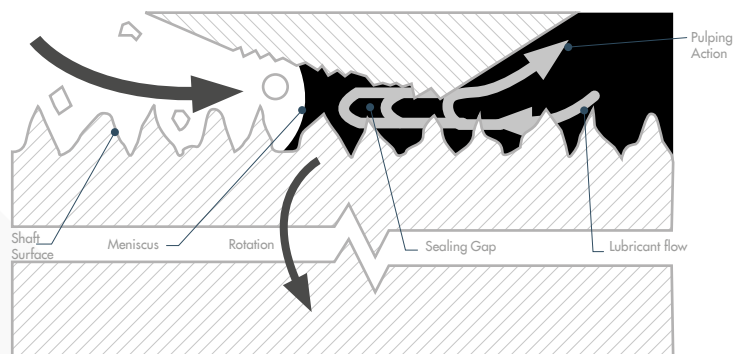

Exhibit 15 – Reverse pumping action by the Seal Lip maintains the lubricant film and prevents leakage.



When the seal is molded, its surface is very smooth; during the Break-In period the asperities are formed.

The macrogeometry of the Lip is another key factor for the success of the Seal; the most important features are the Lip angles (α and β) and the Spring location ($R > 0$; Garter Spring axis towards the air side) – see Exhibit 16

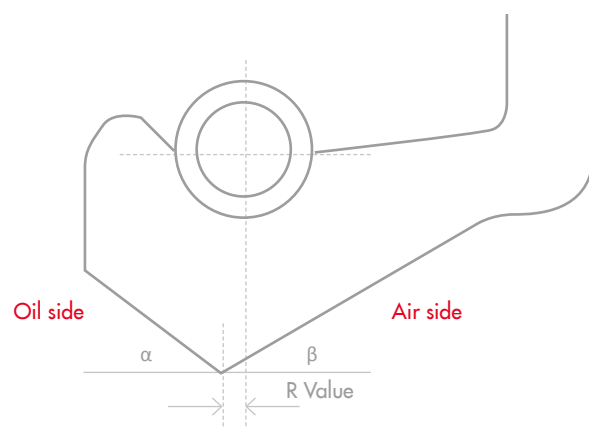

Exhibit 16 – Macrogeometry of the Seal Lip

The macrogeometry factors determine the profile of the static contact pressure curve but this is not relevant for the Reverse Pumping; in fact, the lubricant film pressure in steady-dynamic conditions is axially steady in the Sealing Region.

As it can be seen in Exhibit 11, during rotation, there is a circumferential shear under the Lip apex due to the viscoelastic behavior of the elastomer that deforms it along the circumference. Given the different magnitude of the angles α and β , the axial location of the maximum displacement is closer to the fluid side.

The pumping rate is connected with the length of the minute cracks on the Seal Lip Edge; after the Run-In Phase, the crack length remains constant as the pumping rate.

The sealing characteristics are related to the circumferential Seal Lip deformation occurring at an axial location closer to the liquid side than to the air side.

The circumferential Seal Lip deformation during steady rotation is therefore part of the dynamic sealing mechanism.

Since the Reverse Pumping Mechanism is induced by the deformed asperities or undulations, and since the deformations are produced by the shear stresses that depend on the fluid mechanics of the lubricating film, by consequence, the fluid mechanics of the lubricating film and the deformation of the Lip are coupled.

Furthermore, the Reverse Pumping Mechanism and the Load Support Mechanism are coupled.

There is also a link between the sealing mechanism and the surface asperity characteristics of the Lip.

The sealing ability of the Lip correlates with the asperity distribution characteristics. A seal with a large number of asperities on the Lip surface, in the sealing zone, will have a high pumping rate, while a Lip with few asperities will have a very low pumping rate.

The Break-In Phase and the Shaft surface roughness are decisive for the formation of the asperities.

If the Shaft surface is too smooth, the Seal Lip will not break properly and leakage will occur; conversely, if the Shaft surface is too rough, gross Lip wear occurs before the protective lubricant film can develop, and again leakage occurs.

Also, the Shaft surface must satisfy some requirements (the Shafts are normally finished by plunge grinding); the surface must not be too smooth or too rough, and the lead angle must be close to 0° .

In the chapter “Shaft”, the details will be explained; a standard range for R_a is accepted between 0.20 to $0.50 \mu\text{m}$ though R_a is not the only relevant roughness parameter to be considered.

It has been experimented and numerically verified that the film thickness is fairly uniform in the axial direction, except the edges, and the pumping rate increases almost linearly with the increasing speed. In the normal non-leaking configuration, a meniscus is separating the liquid from the air, as shown in Exhibit 17.

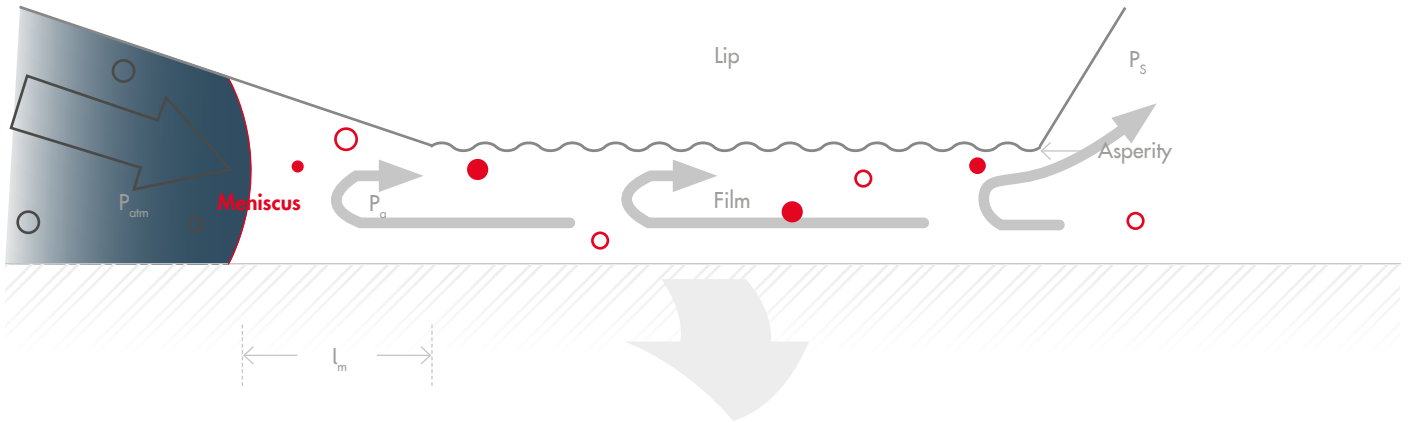

Exhibit 17 – Reverse Pumping Mechanism. A concave meniscus separates the liquid film from the air side.

Under equilibrium conditions, the meniscus will be located at some axial distance from the edge of the sealing region (L_m in Exhibit 17) so that the net leakage through the film is zero. The flow in the sealing region can be seen as the superposition of the leakage flow due to the sealed pressure and the reverse pumping flow. Under equilibrium conditions, the two flows balance each other, giving zero net flow rate.

If a working Lip Seal is conversely mounted (installed backwards), it will leak profusely. This is connected with the effects of the macrogeometry of the Seal Lip angles and the garter spring location; in this case, the Reverse Pumping effect will contribute to increase the natural leakage of the seal and a profuse leaking will occur.

Bearing Seals with grease lubrication work differently. In such case, often the primary concern is the exclusion of contaminants rather than the retention of the lubricant (given the high viscosity). For this purpose, sometimes the same Radial Spring-loaded Lip Seals can be reversely mounted with the

air side facing the bearing interior and the oil side facing the exterior and contaminants. The seals are lubricated by the small amount of oil bleeding from the grease which is much less than the pumping capability of the seal. The small amount of pumped out grease prevents wear and helps to keep away liquid contaminants. However, another type of Radial Shaft Seal without a garter spring is often used.

Thermal effects are extremely important to Lip Seals operation, both directly and indirectly. It is to be noted that three important modes of rotary Lip Seal failure are strongly related to the temperature of the Lip compound: elastomer ageing, swelling, and lubricant coking.



6. PTFE Radial Shaft Seal Concept

The Elastomer Lip Radial Shaft Seal finds its functional limitations when either excessive tangential shaft speeds or chemical aggressions by the fluids to be sealed, or even dry service conditions stress the Seal.

Under these circumstances, the PTFE Radial Shaft Seals can be used; Exhibit 18 shows three typical PTFE Radial Shaft Seals: a simple one (a), one with

the elastomer wiper lip (b), and one with the bonded PTFE Lip (c).

The norm that standardizes the types and sizes of the PTFE Radial Shaft Seals is the ISO 16589.

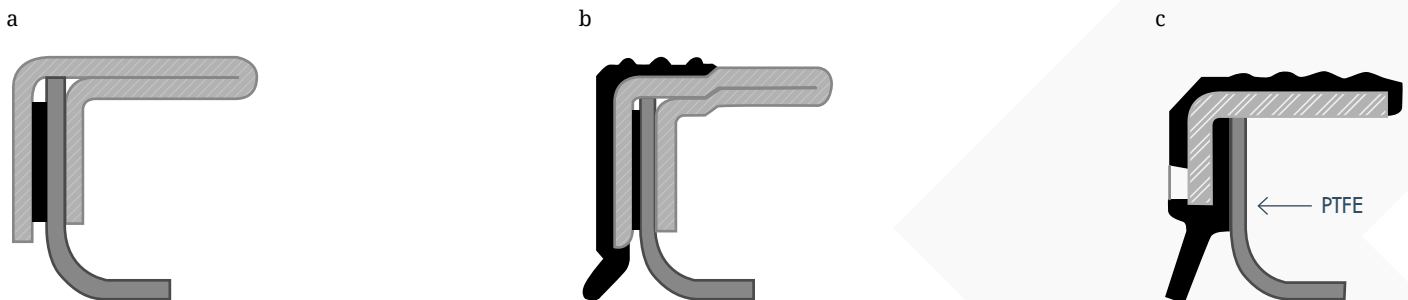

Exhibit 18 – Typical PTFE Radial Shaft Seals; single lip version (a), version with the additional elastomer wiper lip (b) and version with the bonded PTFE lip with the rubber lining (c)



6.a Self Lubrication Mechanism

PTFE (PolyTetra-FluoroEthylene) shows the peculiar characteristics of a very low Friction Coefficient, a wide operating temperature range (in both low T and high T spans), and an excellent chemical resistance.

Its self-lubricating performance allows to work in absence of any lubricant; this feature is also relevant for reducing the friction force in operating conditions and it's due to the PTFE polymer Transfer Film on the mating Shaft steel surface Sealing Area (see Exhibit 19).

This phenomenon occurs during the Break-In Phase (referring to Chapter 5, this is the initial rotation of the Shaft after the assembly of the PTFE Lip Radial Shaft Seal) due to the PTFE Lip abrasion by the mating steel surface roughness.

As mentioned, the Transfer Film is essential for reducing the friction between the PTFE Lip and the Shaft because it creates a PTFE-PTFE sliding contact, it reduces the wear of the PTFE Lip because it prevents the contact by a harder surface, and consequently, it contributes to reduce the Friction Torque and the Friction Heat on the sealing area.

However, once more it is to be underlined that the Steel Shaft Surface finishing must be controlled for the correct working conditions of the PTFE Lip; in fact, the formation of the PTFE Transfer Film occurs when the maximum roughness height of the Shaft surface is $Rz < 1.5\mu\text{m}$.

For higher maximum roughness height $Rz > 1.5\mu\text{m}$, the PTFE Lip countersurface would aggressively be worn by detaching material particles without forming the Transfer Film on the Sealing Surface.

Besides, the controlled Shaft surface roughness is essential for the effective sealing as well, as explained in Chapter 9.

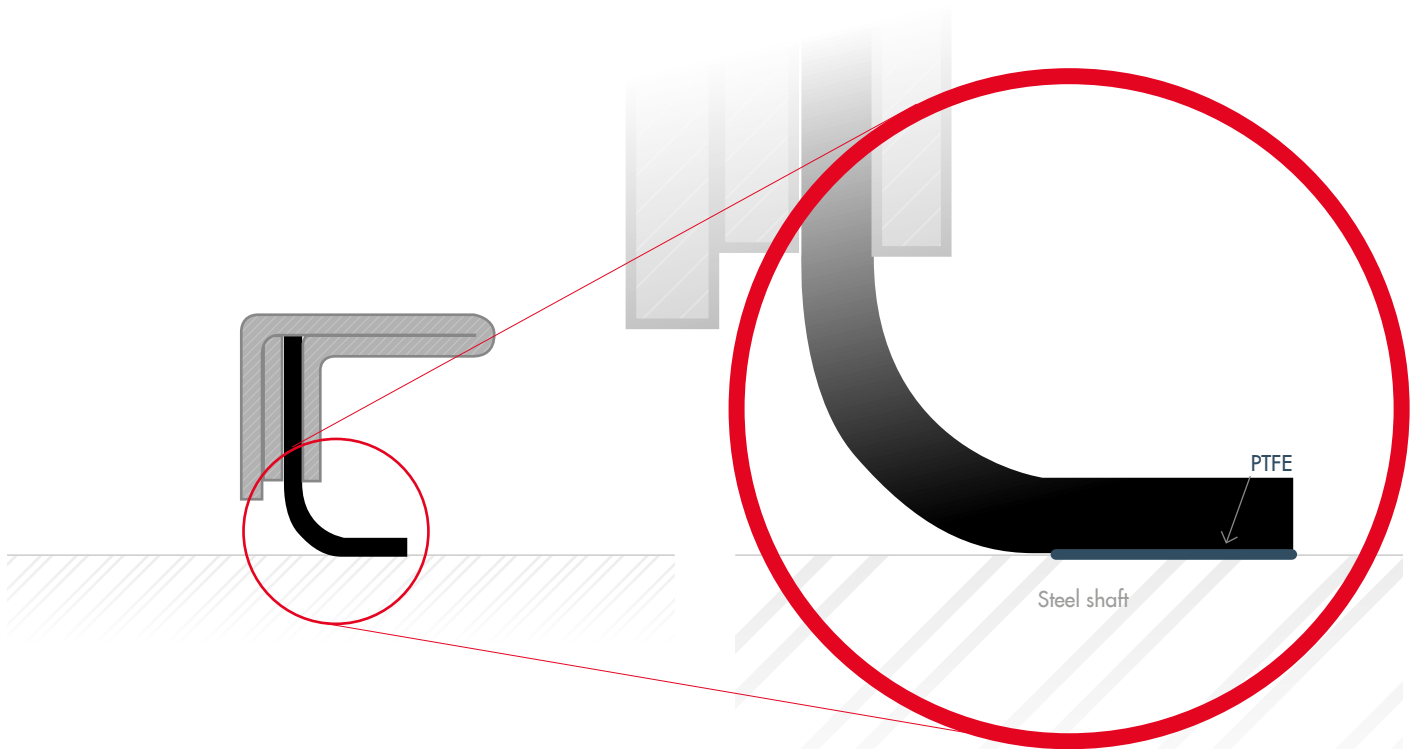

Exhibit 19 – Self Lubricating effect. The PTFE Transfer Film is formed on the mating Shaft surface sealing area under the PTFE Lip. The magnitude of this film thickness is of the order of 100nm.

During the Break-In Phase, Friction Force is quite high due to the Shaft steel surface asperities scraping the PTFE Lip counter surface and causing a high wear; in this phase the PTFE polymer Film Transfer occurs causing the drop of the Friction Force and the reduction of the further wear.

When the Steady Dynamic State is reached, the Friction Force trend is almost flat, and the wear progression keeps a modest and stable gradient.

At this stage, the Self Lubrication Mechanism is effective and the PTFE Lip surface slides against the Transfer Film made of the same polymer, reaching the lowest Friction Coefficient and the minimum wear due to the homogeneous material of the mating surfaces.

6.b Static Sealing Condition

The PTFE Seal Lip has a free inner diameter smaller than the Shaft diameter on which it shall be assembled. During the assembling on the Shaft, the PTFE Lip gets stretched to assume the Shaft size and this interference, equal to the gap between the Shaft diameter and the free PTFE Lip inner diameter, produces a tightening radial force against the Shaft.

Considering that PTFE is much stiffer than elastomer compounds (E-Modulus ranging from 0.4 to 2.5 GPa versus E-Modulus of rubber compounds <10 MPa), the resulting tightening radial force is much higher compared to the one of the Elastomer Seal Lip and it doesn't need the garter spring.

The applied Contact Pressure on the Sealing Area produced by the Radial Force prevents the leakage of the fluid to be sealed (see Exhibit 20).

Likewise, the interference between the Outer Seal diameter and the Housing diameter produces the static sealing on the Housing.

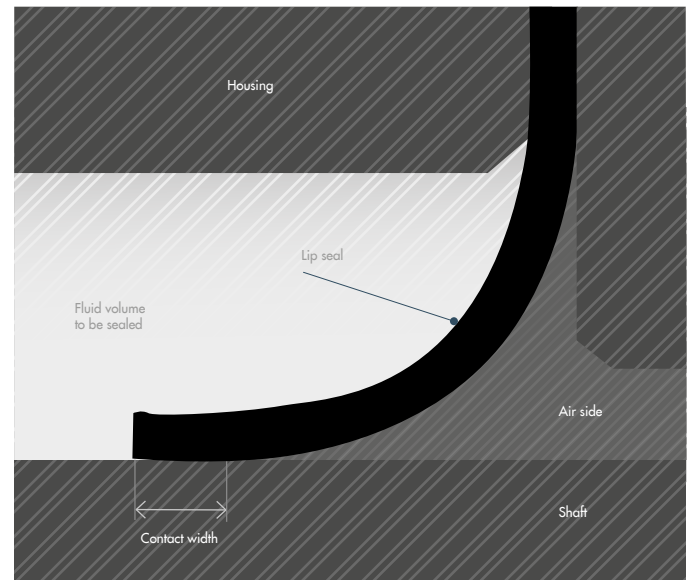

Exhibit 20 – PTFE Sealing Lip Assembled on the Shaft. On the contact width around the Shaft (Sealing Area) the exerted Radial Force due to the interference between the free PTFE Lip inner diameter and the Shaft diameter produces the Contact Pressure that prevents the leakage of the fluid to be sealed.

6.c Dynamic Sealing Condition

The bigger contact width, the different microgeometry, and the different material composition of the PTFE Lip, compared with the Elastomer Sealing Lip, do not produce the asperities on the PTFE Lip contact surface with the undulations that produce the reverse pumping during rotation.

There is no reverse pumping effect by the PTFE Sealing Lip. Up to a critical speed, the Dynamic Sealing is produced by the Contact Pressure only. Beyond this limit, the Dynamic Sealing can only be granted by a hydrodynamic pumping effect by means of a Helix Cut on the PTFE Lip surface that produces a shear flow back to the Oil Side (see Exhibit 21).

a – HELIX CUT

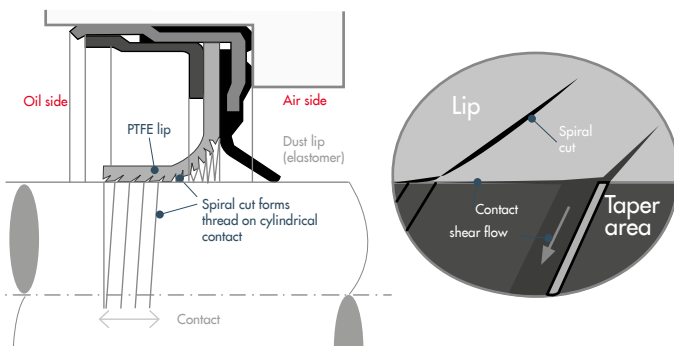

b – ENGRAVED FURROW GEOMETRICS BETWEEN TWO CLOSED RINGS

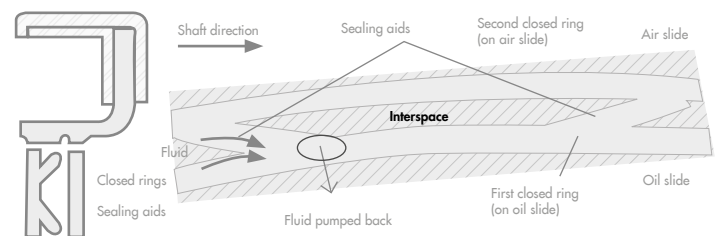

Exhibit 21 – (a) The Helix Cut on the PTFE Lip surface in contact with the Shaft forms a fluid thread on the Shaft surface with a shear flow of fluid towards the Oil Side that pumps back the fluid and maintains the Dynamic Sealing during rotation. (b) The engraved Furrows between two Closed Rings convey the fluid flow back to the Oil Side during rotation.

It is worth making some considerations comparing the Elastomer Lip performance with the PTFE Lip performance for the Radial Rotary Seals.

I. FRICTION TORQUE

The Coefficient of Friction of the PTFE is much lower than the Coefficient of Friction of any Elastomer Compound. However, the Friction Torque is generated by the Friction Force that is given by the Coefficient of Friction multiplied by the Radial Force. Even though the Radial Force of the PTFE seal is higher than the radial force of the Rubber Seal Lip, the resulting Friction Force is smaller due to the lower Coefficient of Friction of the PTFE. PTFE Sealing Lips can work in dry conditions because of their Self Lubrication effect; none of the Elastomer Sealing Lips can work without lubrication.

II. CHEMICAL RESISTANCE

The chemical inertia shown by PTFE is much higher and broader than any Elastomer Compound.

III. TEMPERATURE RANGE

The operating temperature range of the PTFE Lip covers virtually the range between -200°C / +250°C which is broader compared to the Elastomer Lips. It

is important to notice that, given the higher Friction Force, the overheat produced under the PTFE Lip is much higher than the overheat produced under the Elastomer Lip.

IV. OVER TEMPERATURE UNDER THE SEALING LIP

For PTFE Sealing Lips, the contact width with the Shaft Surface is wider due to the different geometry. This condition produces the benefit of reducing the Temperature gradient along the axial contact zone. This is an advantage when high overheating is produced on the PTFE Lip.





V. PRESSURE

The Working Pressure Range is similar between the two types of Lips (Rubber Lip and PTFE Lip). In order to increase the applicable fluid pressure, specific geometries and concepts must apply.

VI. TANGENTIAL SPEED

The Working Speed of the Elastomer Seal Lip is limited by overheating temperature and hydrodynamic pumping. PTFE Lips can be used for high tangential speed levels.

7. Seal Types

Product	Image	Descriptions
Radial Shaft Seals		
Type A		Standard radial shaft seal with sharply cut or pressed sealing lip and rubber coated metal cage on the outside diameter. Good sealing effect with bearing oils and greases.
Type A		Standard radial shaft seal with sharply cut or pressed sealing lip and coated metal cage on the outside diameter. Good sealing effect with bearing oils, engine oils and greases in a wider range of speed, temperature and at a higher chemical resistance.
Type AS		Standard radial shaft seal with sharply cut or pressed sealing lip and coated metal cage on the outside diameter. Good sealing effect with bearing oils and greases. Design with additional dust protection lip.
Type AS		Standard radial shaft seal with sharply cut or pressed sealing lip and coated metal cage on the outside diameter. Good sealing effect with bearing oils, engine oils and greases in a wider range of speed, temperature and at a higher chemical resistance. Design with additional dust protection lip.
Type AW (available on request)		Radial shaft seal with sharply cut or pressed sealing lip and waved rubber coated metal cage on the outside diameter suitable for wider tolerances on the bore at lower press-fit forces. Good sealing effect with bearing oils and greases.





Technical data					
The limit values specified here for the operating temperature, circumferential speed and system pressure are maximum values which are only valid as a stand-alone property. The combination of the physical application parameters leads to reduced limit values.					
Material	Hardness	Colour	Operating temperature (°C)	Peripheral speed*	
NBR	70 Shore A	black	-40 to +100	<10 m/s	
FKM	80 Shore A	brown	-20 to +200	>10 m/s	
NBR	70 Shore A	black	-40 to +100	<10 m/s	
FKM	80 Shore A	brown	-20 to +200	>10 m/s	
NBR / FKM	70 Shore A / 80 Shore A	black / brown	-40 to +100 / -20 to +200	<10m/s / >10m/s	

*special seal lip design at higher peripheral speed required





































System pressure	Peculiar features			Key applications							Link to Webshop
	Dust protection	Low friction	High speed & high T resistance	Gear-motors & gearboxes	Hydraulic gear pumps & motors	Compressors & pumps	Driveline & axles	Spindles	Robotics	Agitators & mixers	
< 0.5 bar	<input type="radio"/>	<input type="radio"/>	<input type="radio"/>	<input checked="" type="radio"/>	<input type="radio"/>	<input checked="" type="radio"/>	<input checked="" type="radio"/>	<input type="radio"/>	<input type="radio"/>	<input type="radio"/>	
< 0.5 bar	<input type="radio"/>	<input type="radio"/>	<input checked="" type="radio"/>	<input checked="" type="radio"/>	<input type="radio"/>	<input checked="" type="radio"/>	<input checked="" type="radio"/>	<input type="radio"/>	<input type="radio"/>	<input checked="" type="radio"/>	
< 0.5 bar	<input checked="" type="radio"/>	<input type="radio"/>	<input type="radio"/>	<input checked="" type="radio"/>	<input type="radio"/>	<input checked="" type="radio"/>	<input checked="" type="radio"/>	<input type="radio"/>	<input type="radio"/>	<input type="radio"/>	
< 0.5 bar	<input checked="" type="radio"/>	<input type="radio"/>	<input checked="" type="radio"/>	<input checked="" type="radio"/>	<input type="radio"/>	<input checked="" type="radio"/>	<input checked="" type="radio"/>	<input type="radio"/>	<input type="radio"/>	<input checked="" type="radio"/>	
< 0.5 bar	<input type="radio"/>	<input type="radio"/>	<input checked="" type="radio"/> only FKM type	<input checked="" type="radio"/>	<input type="radio"/>	<input checked="" type="radio"/>	<input checked="" type="radio"/>	<input type="radio"/>	<input type="radio"/>	<input checked="" type="radio"/>	

Product	Image	Descriptions	Material	Hardness	Colour	Operating temperature (°C)	Peripheral speed*
Radial Shaft Seals							
Type ASW (available on request)		Radial shaft seal with sharply cut or pressed sealing lip and waved rubber coated metal cage on the outside diameter suitable for wider tolerances on the bore at lower press-fit forces. Good sealing effect with bearing oils and greases. Design with additional dust protection lip.	NBR / FKM	70 Shore A 80 Shore A	black / brown	-40 to +100 / -20 to +200	<10m/s >10m/s
"Type AP (available on request)		Radial shaft seal for pressurized applications with sharply cut or pressed sealing lip and rubber coated metal cage on the outside diameter. Suitable for high pressure applications, typically hydraulic pumps and motors.	NBR / FKM	70 Shore A 80 Shore A	black / brown	-40 to +100 / -20 to +200	<10 m/s
"Type ASP (available on request)		Radial shaft seal for pressurized applications with sharply cut or pressed sealing lip and rubber coated metal cage on the outside diameter. Suitable for high pressure applications, typically hydraulic pumps and motors. Design with additional dust protection lip.	NBR / FKM	70 Shore A 80 Shore A	black / brown	-40 to +100 / -20 to +200	<10 m/s
Type SAW (SA)		Radial shaft seal with sharply cut or pressed sealing lip and waved rubber coated metal cage on the outside diameter suitable for wider tolerances on the bore at lower press-fit forces. Design without radial spring for lower radial forces.	NBR	70 Shore A	black	-40 to +100	6 m/s
"Type SASW (available on request)		Radial shaft seal with sharply cut or pressed sealing lip and waved rubber coated metal cage on the outside diameter suitable for wider tolerances on the bore at lower press-fit forces. Design without radial spring for lower radial forces. Design with additional dust protection lip.	NBR	70 Shore A	black	-40 to +100	6 m/s
Type B (available on request)		Radial shaft seal with sharply cut or pressed sealing lip and metallic stiffening ring on the outer surface. Good sealing effect with bearing oils and greases. Extremely precise positioning in the housing or location hole. Bore-tolerances to be calibrated according to the recommendations in A+P rotating seals technical guide.	NBR FKM	70 Shore A 80 Shore A"	black / brown	-40 to +100 / -20 to +200	<10m/s >10m/s
Type C		Radial shaft seal with sharply cut or pressed sealing lip and metallic stiffening ring on the outer surface. Good sealing effect with bearing oils and greases. Extremely precise positioning in the housing or location hole.	NBR FKM	70 Shore A 80 Shore A	black / brown	-40 to +100 / -20 to +200	<10m/s >10m/s
Type HTS II		PTFE rotary shaft seal with steel clamping ring on the rear side and self-retightening sealing lip. Design without radial spring with good dry running properties and low friction. Steel clamping ring does not come into contact with the medium.	PTFE/ Carbon		black	-70 to +200	<18 m/s
Type BSB		Diaphragm rotary shaft seal including single lip seal with steel backing ring and support/dust lip for low friction and low wear. Also suitable for repairs as the old running-in track of the first seal is not used and therefore no reworking of the shaft is necessary.	FKM	75 Shore A	turquoise	-30 to +200	<40 m/s
Type DUO (available on request)		Double lip seal to separate two media. Space-saving version available with coated metal cage or metal centering.	NBR FKM			-40 to +100 / -20 to +200	<10m/s >10m/s
Type MHX 2000 M (available on request)		PTFE rotary shaft seal including metal housing with clamped PTFE sealing lip. Self-tightening sealing lip without metal spring. Good dry running properties with low friction.	PTFE/ Carbon			-70 to +200	40 m/s
Type MS (available on request)		PTFE rotary shaft seal including metal housing with clamped PTFE sealing lip. Self-tightening sealing lip without metal spring. Good dry running properties with low friction. Design with additional dust protection lip.	PTFE/ Carbon			-70 to +200	40 m/s
Cassette Seals (available on request)		Cassette Seals provide a higher protection among the range of the Radial Shaft Seals. By means of a labyrinth with a combination of some radial and axial sealing lips, the sealing performance on both inner and outer diameters produces the perfect and reliable isolation between the lubricant side and the harsh outer environment. The filled-in grease in the cavities of the labyrinth assure a much longer life time and a reduced drag torque.	Combination of different materials according to the application				
COMBI Seal		COMBI Seals integrate an excellent inner oil seal function with a strong outer protection from harsh environment. The use of a different material for the outer seal enhances the protection from the external pollution.	Combination of different materials according to the application				
Sleeve		The shaft sleeve is a particularly economical solution to prevent wear on shafts and axles by contact seals. Running surfaces already damaged by run-in marks are successfully replaced by Speedy-Sleeve without any problems, within minutes and with simple hand movements.	Stainless steel				
End Cap*		The End Cap provides a perfect sealing protection for Gear Devices and Gear Boxes where the shaft doesn't pass through. Easy to install, it tolerates higher metal surface roughness and provides a radial static sealing with reliable tightness. It reduces the risk of corrosion and it compensates the resulting gap by the differential thermal expansion between the box case and its metal insert.	NBR	70 Shore A	black	-40 to +100	

*waver rubber design on outer diameter available on request















System pressure	Dust protection	Low friction	High speed & high T resistance	Gearmotors & gearboxes	Hydraulic gear pumps & motors	Compressors & pumps	Driveline & axles	Spindles	Robotics	Agitators & mixers	ask for consulting / link to Webshop
< 0.5 bar	●	○	● only FKM type	●	○	●	●	○	○	●	 
<10 bar	○	○	● only FKM type	●	●	●	●	○	○	○	 
<10 bar	●	○	● only FKM type	●	●	●	●	○	○	○	 
	○	●	○	● only with grease lubricant	○	○	○	○	○	○	 
	●	●	○	● only with grease lubricant	○	○	○	○	○	○	 
< 0.5 bar	○	○	● only FKM type	●	○	○	○	○	○	●	 
< 0.5 bar	○	○	● only FKM type	●	○	○	○	○	○	●	 
< 6 bar	○	●	●	○	○	○	○	○	●	●	 
< 15 bar	○	●	●	○	○	○	○	○	●	●	 
< 0.5 bar	○	○	●	● only FKM type	○	●	●	○	○	●	 
< 1 bar	○	●	●	●	○	●	●	○	●	○	 
< 1 bar	●	●	●	●	○	●	●	○	●	○	 
< 0.5 bar	●	Version with PTFE Lip	Version with FKM or PTFE Lip only	●	○	○	●	○	●	●	 
< 0.5 bar	●	Version with PTFE Lip	Version with FKM or PTFE Lip only	●	○	○	●	●	●	○	 
	○	○	○	●	○	●	●	○	○	○	 
< 0.03 bar	○	○	○	●	○	○	●	○	○	○	 



Product	Image	Descriptions	Material	Hardness	Colour	Operating temperature (°C)	Peripheral speed*
Axial Shaft Seals							
V-Ring Type A		Standard V-ring with short design and straight back. Can be mounted against stop.	NBR	60 Shore A	black	-40 to +100	<12 m/s
V-Ring Type A		Standard V-ring with short design and straight back. Can be mounted against stop.	FKM	60 Shore A	brown	-20 to +150	<12 m/s
V-Ring Type S		Standard V-ring with angled back for better spinning action. Long design and long bearing surface.	NBR	60 Shore A	black	-40 to +100	<12 m/s
V-Ring Type S		Standard V-ring with angled back for better spinning action. Long design and long bearing surface.	FKM			-20 to +150	<12 m/s
V-Ring Type L		Standard V-ring for larger diameters with short design and straight back for mounting against stop. Use in labyrinth sealing solutions.	NBR	60 Shore A	black	-40 to +100	<12 m/s
GAMMA form RB		Axial shaft seal with small installation width and mechanical protection of the sealing lip. The metal housing encloses the sealing lip. Installation with press fit on shaft.	NBR	75 Shore A		-30 to +100	<12 m/s
GAMMA form RBS (available on request)		Axial shaft seal with small installation width and mechanical protection of the sealing lip. The metal housing encloses the sealing lip. Installation with press fit on shaft.	NBR			-30 to +100	<12 m/s

Table 1: Seal type overview.



System pressure	Dust protection	Low friction	High speed & high T resistance	Gearmotors & gearboxes	Hydraulic gear pumps & motors	Compressors & pumps	Driveline & axles	Spindles	Robotics	Agitators & mixers	link to Webshop
< 0.2 bar	●	●	○	●	○	○	○	○	○	○	 
< 0.2 bar	●	●	●	●	○	○	○	○	○	○	 
< 0.2 bar	●	●	○	●	○	○	○	○	○	○	 
< 0.2 bar	●	●	●	●	○	○	○	○	○	○	 
< 0.2 bar	●	●	○	●	○	○	○	○	○	○	 
< 0.2 bar	●	●	○	●	●	●	●	●	●	●	 
< 0.2 bar	●	●	○	●	●	●	●	●	●	●	 

8. Garter Spring

The Seal Lip apex exerts a Radial Force against the mating Shaft surface given by the superposition of three effects: the rubber beam deflection force, the rubber hoop force of the elastomer due to the Seal Lip interference, and the Garter Spring load.

Like the rubber beam deflection force, the rubber hoop force will show variations due to temperature and aging caused property changes of the rubber. The radial force created by the garter spring is very constant at changing ambient conditions as well as over the service life of the seal.

RRSS DIN 3760 AS TYPE

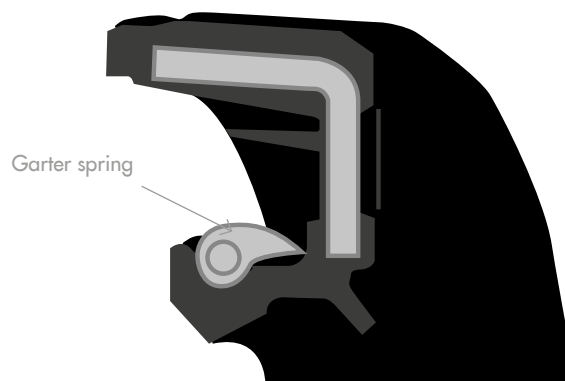

The advantages of a garter spring can be summarized as follows:

- Complementary energizing function which helps keeping a stable sealing at higher shaft speeds
- Compensation of the seal wear
- Compensation for the seal relaxation and compression set

Every spring is designed with specific length, winding diameter and wire strength. Garter springs are generally not required for grease retention applications.

8.1. Garter Spring Materials:

Typical garter spring materials in sealing applications include: carbon steel, stainless steel (e.g. AISI 302, 316), Elgiloy®, Hastelloy® and Inconel 750. If there is a risk of corrosion from seawater, detergent or acid solutions, a stainless steel material is mandatory. The material of the garter spring can generally be heat

treated to stabilize the energizing function along the typical operating temperature.

8.2. Garter Spring Types:



Name	Spring type	Description	Seal type	Spring force	Spring material
Slant coil spring		round wire which is coiled and angled along its centerline. Its flat load deflection curve supports in conditions where low friction is the main requirement.	Radial rotary shaft seal with rubber lip	Low	Cold drawn unalloyed spring steel (standard media) Stainless steel 301 (corrosive media) Elgiloy® (aggressive media) Hastelloy® C276 (aggressive media and high temperature)
V spring		Cantilever springs or finger springs: metal strip, punched into a serpentine and bent to U or V shape.	PTFE jacket seals for rotary sealing	Medium	Stainless steel 301 (standard & corrosive media) Elgiloy® (aggressive media) Hastelloy® C276 (aggressive media and high temperature)
Helical spring		A metal ribbon which is coiled into a helix generating a high stiffness spring especially suitable for static or very low dynamic rpm when sealing effect is more important than friction. In some cases it can also be implied to seal gases with a suitable seal. The closely wound helical spring has a precisely calculated initial preloading force which is stabilized by a heat treatment executed at a higher temperature than the operating conditions.	PTFE jacket seals for rotary sealing	High	Stainless steel 301 (standard & corrosive media) Elgiloy® (aggressive media) Hastelloy® C276 (aggressive media and high temperature)

Table 2: Summary of the spring designs for radial shaft seals.

9. Shaft

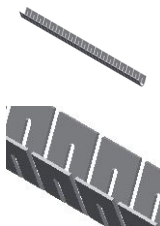
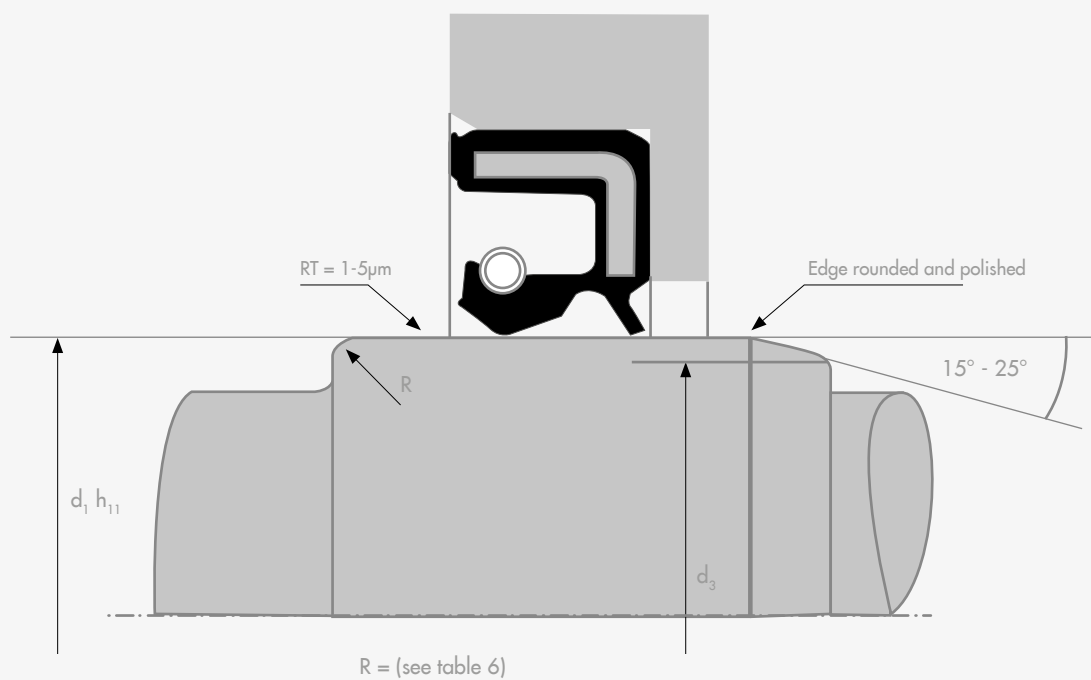

Exhibit 22 – Shaft chamfer and radius
for assembling of rotary shaft seals type
AS acc. DIN 3760

9.1. Shaft dimensions and seal contact area

Shaft diameter d1

For the shaft diameter d1, the ISO tolerance zone h11 must not be exceeded within the area of the sealing contact zone (table 3)

Shaft diameter d1 [mm]	Tolerance d1	Shaft diameter d1 [mm]	Tolerance d1
up to 3	0 -0.060	over 50 up to 80	0-0.190
over 3 up to 6	0 -0.075	over 80 up to 120	0-0.220
over 6 up to 10	0 -0.090	over 120 up to 180	0-0.250
over 10 up to 18	0 -0.110	over 180 up to 250	0-0.290
over 18 up to 30	0 -0.130	over 250 up to 315	0-0.320
over 30 up to 50	0 -0.160	over 315 up to 400	0-0.360

Table 3: Shaft diameter and tolerances

Exhibit 23 –
Contact surface area without protective lip

a) No eccentric running
b) Running surface on shaft

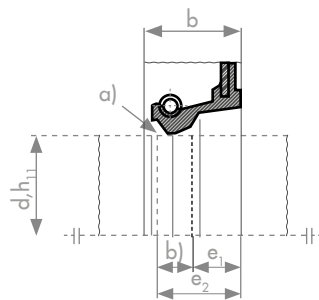
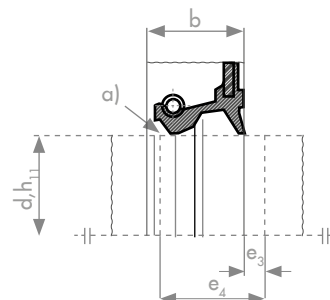

Exhibit 24 –
Contact surface area with protective lip



Sealing width b	Shaft seals without protection lip		Shaft seals with protections lip	
	e ₁	e ₂ min.	e ₃	e ₄ min.
7	3.5	6.1	1.5	7.6
8	3.5	6.8	1.5	8.3
10	4.5	8.5	2	10.5
12	5	10	2	12
15	6	12	3	15
20	9	16.5	3	19.5

Table 4: Shaft contact surface area

9.2. Shaft Radius and Shaft Chamfer

9.2.1. Shaft Chamfer

(Both assembly directions)

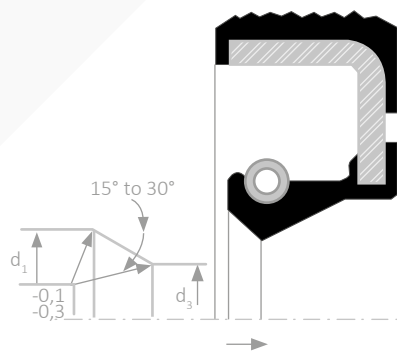

Exhibit 25 – Chamfer requirements
- shaft assembly direction from face side to bottom side of seal

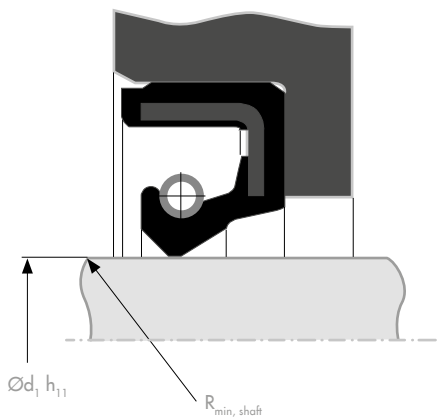

Exhibit 26 – Shaft assembly direction from bottom side towards face side of seal

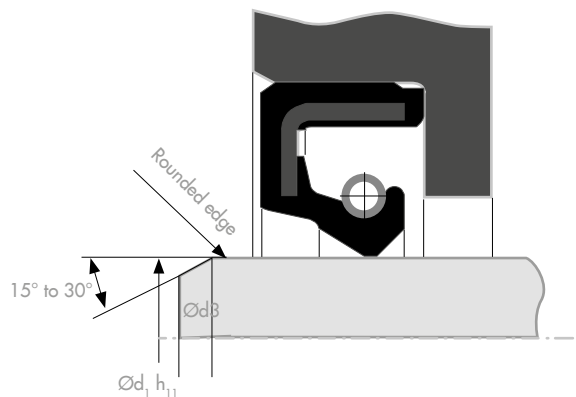
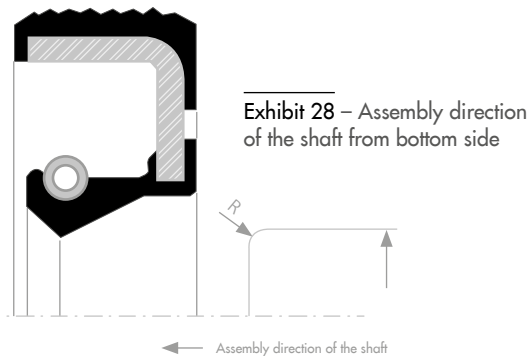

Exhibit 27 – Shaft assembly direction from face side towards bottom side of seal

Shaft diameter d1 [mm]	Shaft diameter d3 max. [mm]	Shaft diameter d1 [mm]	Shaft diameter d3 max. [mm]
d1 < 10	d1 - 1.5	50 < d1 < 70	d1 - 4.0
10 < d1 < 20	d1 - 2.0	70 < d1 < 95	d1 - 4.5
20 < d1 < 30	d1 - 2.5	95 < d1 < 130	d1 - 5.5
30 < d1 < 40	d1 - 3.0	130 < d1 < 240	d1 - 7.0
40 < d1 < 50	d1 - 3.5	240 < d1 < 480	d1 - 11.0

Table 5: Shaft chamfer

9.2.2. Shaft Chamfer (Shaft assembly direction from bottom side only)



R	
without protective lip	0.6
with protective lip	1

Table 6: Shaft radius
(assembly direction from bottom side)

9.3. Surface Quality and hardness of the Shaft

Surface roughness	Shaft Øh11: [µm]
Ra [µm]	0.2 - 0.8
Rz [µm]	1-5
Rzmax [µm]	6.3
Material fraction Rmr Bearing ratio tp	50%....70%
Rmr measured in cut depth $c = 0.25 \times Rz$; reference Cref = 5% tp measured at $0,5 \times Rt$	
Shaft hardness min. 55 HRc hardness depth 0,3 greyliner after nitration hardening smoothed (if perimeter speed <4 m/s 45 HRc is sufficient)	
Shaft surface must be free of helix structure	

Table 7: Shaft surface requirements

The surface roughness should be balanced to avoid too much friction (i.e. high overtemperatures) or to hinder the lubrication efficiency. Wettability and fluid film thickness are indeed considerably influenced by the degree of surface finish of the shaft. If the roughness is too high, the resulting high friction would wear the lip leading to leakage. On the other hand, if the roughness is too low, the lubricant may not be able to reach and keep a stable lubrication at the sealing edge, which would lead to overheating, cracking and resulting leakage. For this reason, choosing the right roughness is always a result of a suitable trade off between the

system operating conditions. The roughness, meaning the variation in the height of a surface relative to a reference plane, can be expressed with several parameters according to ISO 4287 standards:

- Rz (Average peak-to-valley height): The average peak-to-valley roughness amplitude Rz represents the average of the single maximum roughness amplitudes in 5 different and consecutive gauge lengths.



$$R_z = \frac{1}{n} (R_{z1} + R_{z2} + \dots + R_{zn})$$

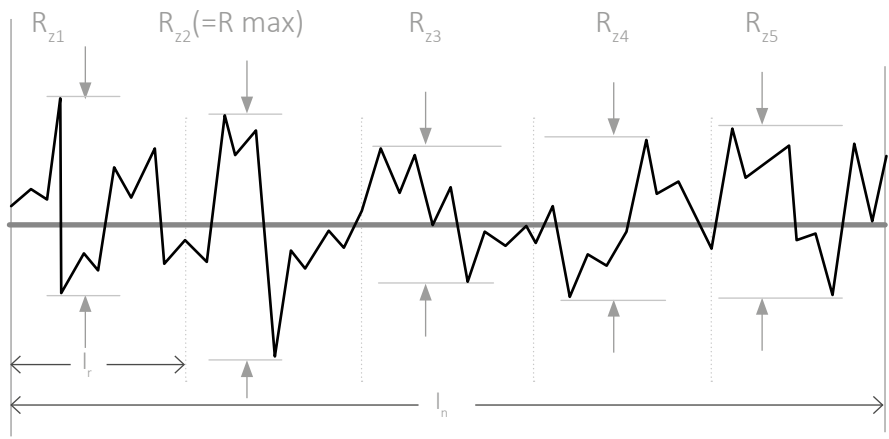

Exhibit 29 – Measurement and calculation of R_z (Average peak-to-valley height)

- R_p , R_{max} or R_y (Maximum peak-to-valley height): The maximum roughness amplitude R_{max} is the largest between the highest peak-to-valley distances measured within 5 different gauge lengths.
- R_a (Average roughness or average height): The average roughness R_a is the arithmetic average of the absolute values of all the distances of the roughness profile R from the mean line along the complete gauge length l_n .

$$R_a = \frac{1}{l} \int_0^l |Z(x)| dx$$



Exhibit 30

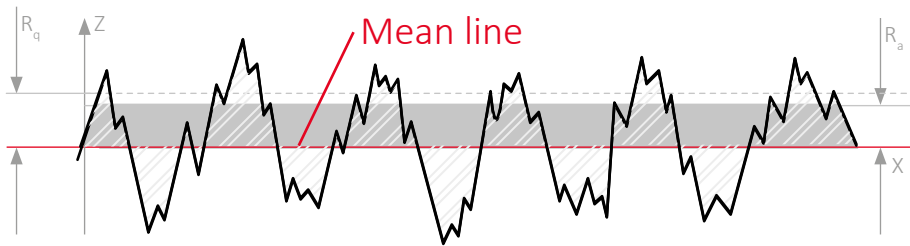

- R_q or RMS (Variance of the height distribution): The square root of the arithmetic mean of the squares of the vertical distance from the reference line.

$$R_q = \sqrt{\frac{1}{l} \int_0^l Z^2(x) dx}$$

Bearing ratio tp / material fraction R_{mr} :

Another important surface parameter vital in the use of seals is the material fraction R_{mr} or the bearing ratio tp (%).

The highest peaks can be sometimes removed by honing or forming (e.g. rolling, stretching or

burnishing). However, sufficient cavities should remain to act as lubricating pockets ensuring correct lubrication. Finally, the pore size in the area around the sealing surface should be max. 50 μm (e.g. for cast iron shafts).

$$R_{mr} = \frac{1}{l_n} (L_1 + L_2 + \dots + L_n) 100 [\%]$$

Exhibit 31

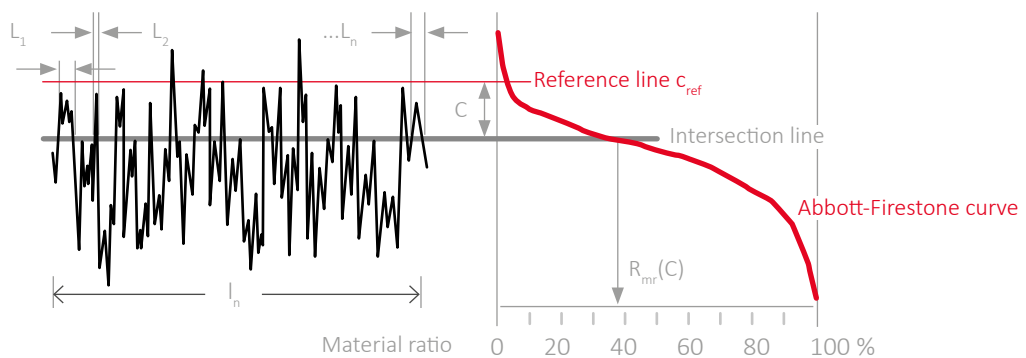



Material ratio R_{mr} (ASME: bearing length ratio tp) is the ratio expressed in percent of the material-filled length to the evaluation length l_n at the profile

section level C. The profile section level C is the distance between the evaluated intersection line and the specified reference line C_{ref} .



This table shows how given R_a , R_z and R_{mr} together can better describe the mating metal surface roughness.

Exhibit 32

Surface Profile (μm)	R_a	R_z	R_{mr}
Closed Profile Form 	0.1	1.0	70%
Open Profile Form 	0.2	1.0	15%

Hardness

- min. 45 HRC for normal applications
- min. 55 HRC for intrusion of dirt from the outside or polluted media as well as at peripheral speeds > 4m/s
- The hardening depth should be at least 0.3mm.

Lead free shaft surface and shaft lead test

Shaft lead can cause negative effects to the sealing function as well as to the service life of rotary seals. Any helix structure on the shaft surface must be prevented. In this regard, the following method can be employed to help ensuring the absence of a shaft lead.

Steps:

1. Clamp the shaft horizontally on a spindle ensuring that the shaft is leveled.
2. Lightly wet the shaft with low viscosity oil.
3. Wrap around the shaft a thread of 0.23mm diameter with a weight of 30g for $\varnothing < 100\text{mm}$ or 50g for $\varnothing > 100\text{mm}$. The thread should be in contact with approx. 2/3 of the shaft circumference without directly touching the thread knot.

4. Slowly rotate the shaft at constant rpm between 20 to 60 rpm, first clockwise and then counterclockwise.

- May the thread axially move in opposite directions respectively for clockwise and counterclockwise rotations, this indicates a considerable lead is present.
- Otherwise, may the thread axially move in the same direction respectively for clockwise and counterclockwise rotations, this indicates the shaft is not leveled and setup adjustments should be taken.
- Finally, if the thread stays stationary on the same position, this is a good indication that a shaft lead may not be present. However, complete certainty cannot be ensured. It could happen that some leads may not be detected.

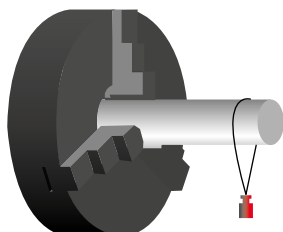
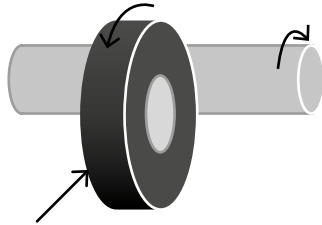

Exhibit 33 – Illustration of the test set-up to identify if a shaft lead is present



Plunge grinding

We recommend plunge grinding (without axial feed) as a processing procedure to create a lead free surface. However, some parameters must be observed for plunge grinding to guarantee a lead-free surface. The rotational frequency ratio between the grinding wheel and the workpiece must not be an integer. An orientation can also be transmitted when the grinding wheel is trued. For this reason, multi-grain dresser tools with as little axial feed as possible or profile truing rolls should be used. The sparking out time should be set for as long as the total sparking out process takes.

The surface hardness of the shaft also has a great influence on the lifespan of the whole sealing system.

Exhibit 34 – Shaft twist-free grindend in plunge cut method. Deburring of the grinding wheels must also be in the form of free feed.

9.4. Deviations in Form and Position

9.4.1. Offset

If the central axis of the shaft and the housing bore axis do not exactly correspond, one speaks of offset. The result of offset is an uneven distribution of radial force at the circumference of the shaft. On the one side of the shaft, the contact pressure is maximal which leads to greater wear. On the opposite side, the contact pressure is minimum, which can lead to reduction of the sealing action.

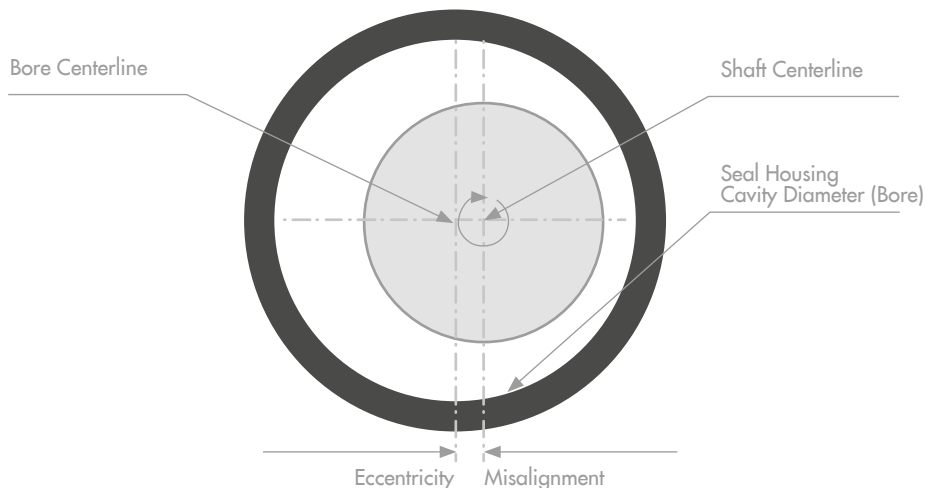

Exhibit 35 – Illustration of the static eccentricity

The figure below shows the maximum permitted values.

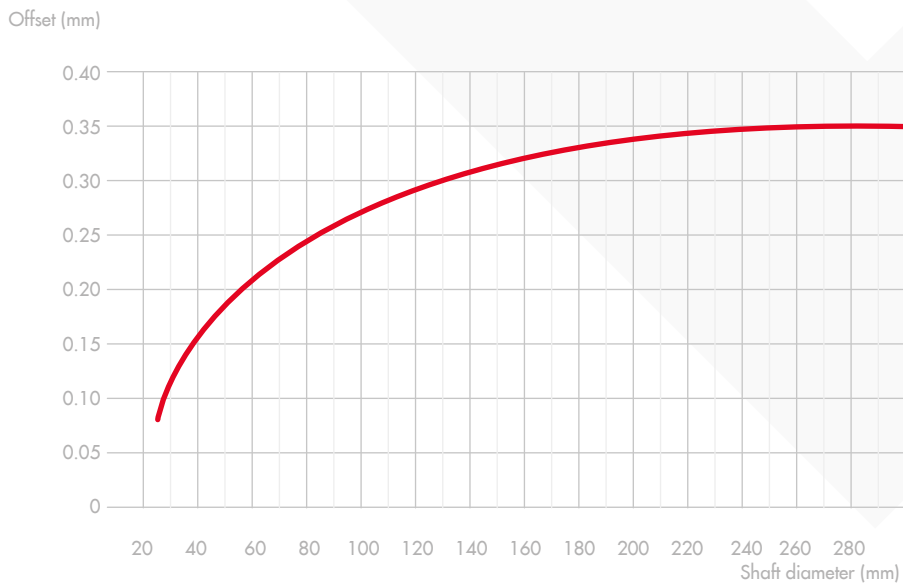

Exhibit 36

9.2. Dynamic run-out deviation

Dynamic Run-out is given by the actual rotation axis of the shaft that deviates from the geometrical axis of the shaft. It can lead to leakage at higher peripheral speeds. If you observe a point on the sealing edge of a shaft seal, a run-out running shaft underneath makes an up and down movement which the sealing lip, due to its mass inertia, can no longer follow after a specific peripheral speed has been reached. A gap is then created through which the medium can escape as leakage.

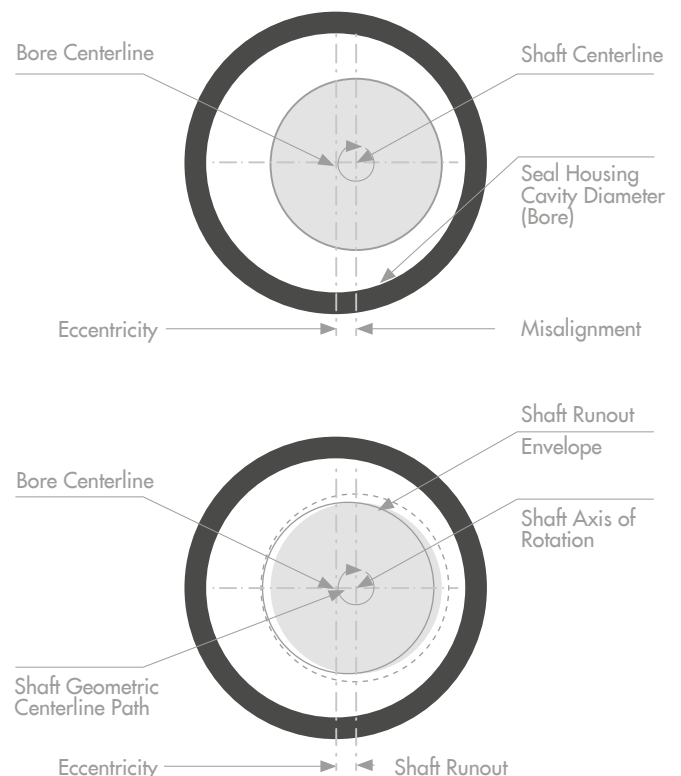

Exhibit 37 – Illustration of the dynamic eccentricity

The figure below shows the maximum permitted values for NBR and FKM (limited values apply for pressurizable types).

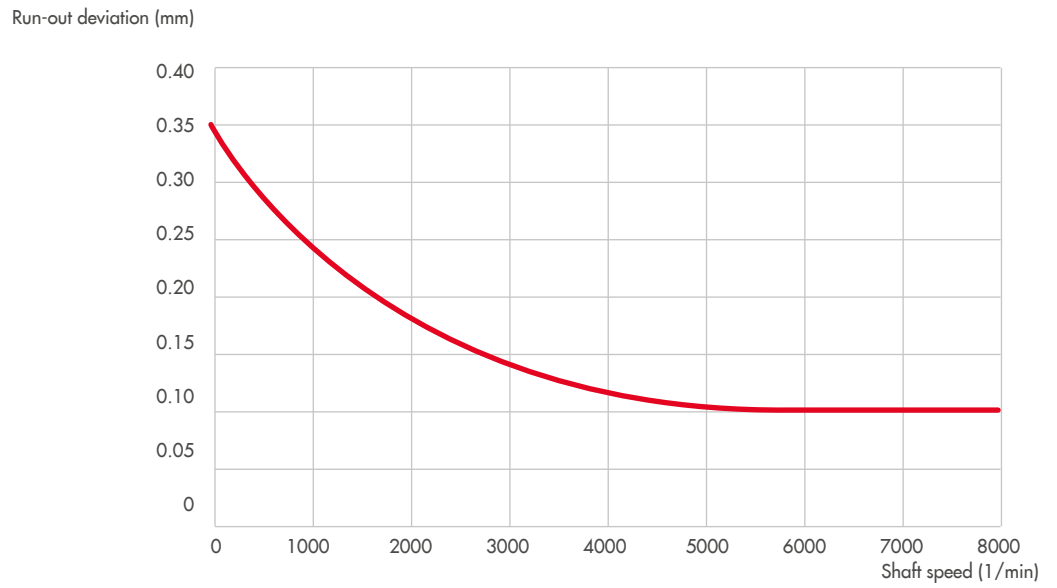

Exhibit 38

10. Housing

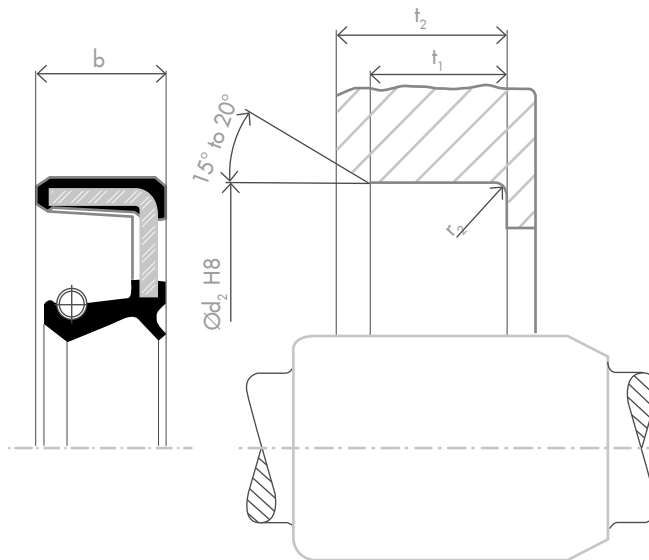

Exhibit 39 – Assembly of the seal to the housing bore

r_2 max : 0.5mm for $b < 10\text{mm}$
 r_2 max : 0.7mm for $b > 10\text{mm}$



10.1. Housing dimensions

Tolerance

For the diameter of the bore, the ISO tolerance field H8 is applicable. Specially adjusted tolerances with less interference can become necessary with thin-walled housings and housings made of brittle materials or materials with low strength. For light metal or plastic housings, we recommend the use of types with rubberized outer diameter, as these can better follow the greater thermal expansion of the housing.

Outside diameter d_2 H8 [mm]	Bore depth t_1 [mm]
up to 20	$b + 0.5$
> 20 up to 80	$b + 1.0$
> 80 up to 120	$b + 1.5$
> 120	$b + 1.5$

Table 8: Min. bore depth t_1

10.2. Housing chamfers

The angle of the lead-in chamfer should be 15° to 20°. The transition between the chamfer and cylindrical surface should be burr-free.

10.3. Surface Quality of static Sealing Point

Surface roughness	Housing (Rubber liner; type A; AS) ØH8; Width $t = \text{Seal width } b + 1,5\text{mm}$:	Housing (metal, and rubber-metal type B; BS) ØH8:
	[μm]	[μm]
R_a [μm]	1.6 - 6.3	0.8 - 3.2
R_z [μm]	10 - 20	6.3 - 16
$R_{z\text{max}}$ [μm]	25	16

Table 9: Surface quality in housing bore

10.4. Deviation of seal position after assembly

Perpendicularity of RRSS pressed in housing bore:

Outer Ø RRSS [mm]	Perpendicularity of RRSS pressed in housing bore: axial height measured 4x every 90° on bottom face
[mm]	[mm]
<20	0.1
20...80	0.2
>80	0.3

Table 10: Max. perpendicularity of RRSS

11. Friction, Drag Torque, Power Absorption

11.1. Friction at sealing contact of shaft sealing

The friction loss between sealing contact line and shaft surface is depending on various parameters.

f = friction coefficient – the nondimensional parameter is evaluated by empiric examinations and is depending on dynamic viscosity of fluid η ; average load at sealing contact and hydrodynamical effects in the sealing area between shaft and sealing contact zone.

p_m = averaged load calculated as:

$$p_m = \frac{P_L}{b} \text{ [N/mm}^2\text{]}$$

p_L = load by contact length:

$$\frac{F_r}{(\pi \cdot d)} \text{ [N/mm]} \text{ (} F_r \text{: Radial force of sealing lip against shaft surface)}$$

u = circumferential speed calculated as: $u = 2 \pi \cdot n \cdot \frac{d}{2}$

n = rotation speed of shaft

d = diameter shaft

b = Width of contact zone



Contact zone of sealing lip against shaft surface:

$$F_{\text{(Radial Force)}} = F_{\text{spring}} + F_{\text{sealing lip}}$$

($F_{\text{sealing lip}}$ by tension of rubber lip)

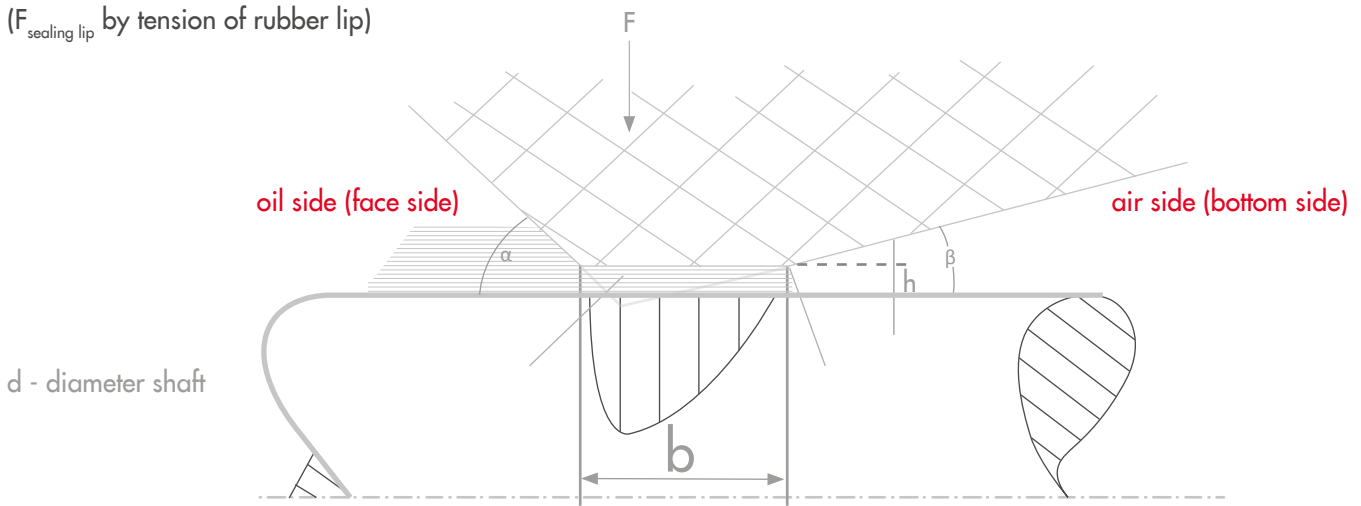

Contact width of sealing lip= b

Exhibit 40 – Contact zone of sealing lip against shaft surface

The friction power loss P_R is calculated as:

$$P_R = f \cdot p_m \cdot u \cdot \pi \cdot d \cdot b$$

The calculation of P_R is showing the parameters with potential to improve friction loss:

f , friction coefficient as a result of the hydrodynamical effects and material, p_L , load by contact length and b , width of contact zone of sealing lip

An example calculation is showing the high level of energy to be absorbed by the system:

Example: $d = 45\text{mm}$; $Fr = 15\text{N}$; $n = 4,500/\text{min}$

The friction loss is absorbed as heat power and must be transferred by thermal conduction via system media, shaft and housing.

$$f = 0.4 \text{ (typical value)}$$

$$b = 0.15\text{mm}$$

$$p_L = 0.11 \text{ N/mm}; p_m = 0.71 \text{ N/mm}^2$$

$$u = 10.6 \text{ m/s}$$

$$P_R = 63.62 \text{ W}$$

$$P/A = 300 \text{ W/cm}^2 \text{ (Cooking plate: } 8 \text{ W/cm}^2\text{)}$$

f = friction coefficient – the nondimensional parameter is evaluated by empiric examinations and is depending on dynamic viscosity of fluid „ η “ ; average load at sealing contact and hydrodynamical effects in the sealing area between shaft and sealing contact zone

$$b = \text{Width of contact zone}$$

$$p_m = \text{averaged load calculated as}$$

$$p_L = \text{load by contact length}$$

$$u = \text{circumferential speed}$$

$$P_R = \text{friction power loss}$$

$$P/A = \text{specific power loss by contact area}$$



12. Simulation

Nowadays, finite element analysis (FEA) allows to evaluate potential threats in sealing configurations even before prototypes are made. This ensures a further level of safety and investment savings in rapid prototyping. The following effects in sealing configurations may be verified with the aid of a properly set FEA:

- Deformation
- Volume/void ratios and gland fill
- Stress distribution
- Contact pressure
- Load-deflection
- Stability analysis
- Friction force
- Thermal effects
- Material evaluation
- Seal life prediction

For further verifications, Angst+Pfister also supports its customers in organizing suitable tests aiming to provide additional guarantees for the final design. If necessary, independent testing laboratories are consulted for final verification of results.

13. Testing

Tests for rotary shaft seals are carried out as described in ISO 6194-4:2009-03 “Rotary shaft lip-type seals incorporating elastomeric sealing elements - Part 4: Performance test procedures” or according supplier and customer specified test standards.

13.1 Radial Force Measurement

The radial force of the rotary seal is a main functional parameter for the sealing function and for the determination of friction loss. The measurements are to be implemented in the development of new seal profiles, but also for quality control during series production. The measuring device can be adapted for a broad range of diameters by changing the measuring adapters.

Exhibit 41 – Measurement principle

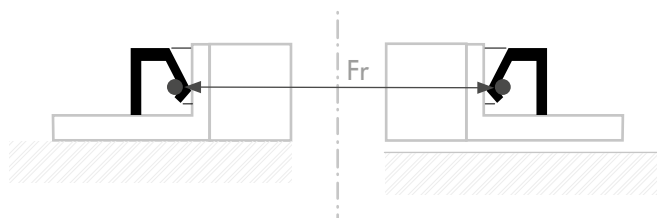

Exhibit 42 – Radial Force Measurement device acc. DIN 3761-9



13.2 Pumping rate Test

Measurement of hydrodynamical pumping function:

- by torque change
 - by time
1. Dry rotation of shaft
 2. Defined oil volume provided on bottom side
 3. Measuring of friction torque change (torque will be low while oil is in sealing gap)
 4. Timing of low friction torque will become the characteristic value of back pumping property.

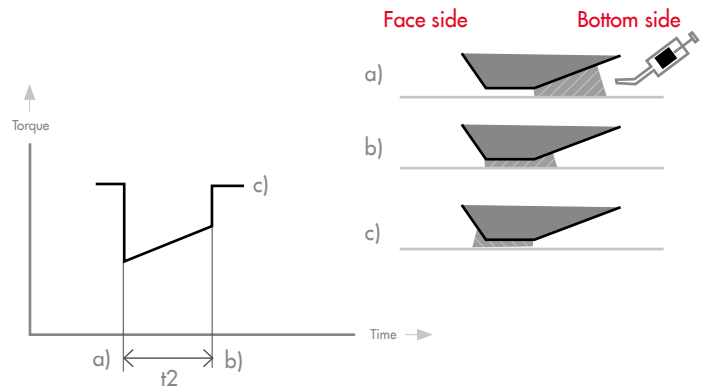

Exhibit 43 – Reverse pumping effect. In the case of a radial lip seal operating at uniform rotation in the dry condition, the drag torque decreases when the air side of the seal lip is flooded with some lubricating oil, until the oil on the lubricant side has been drained. This is the evidence of the reverse pumping effect produced by the Seal Lip in steady dynamic conditions. The flow rate equals the volume of flooded oil divided by the time to get it drained.

13.3 Functional Testing

The sealing function of rotary shaft seals can be proven by the dynamic normal temperature test as described in ISO 6194-4:2009-03, Chapter 5 or in possible variations as agreed between customer and supplier.

The test conditions shall be adapted to the application profile of the product where the seal will be used or is defined according to the supplier specifications for standard applications. Typical parameters to be adapted are: operating temperature, shaft speed, system media and geometrical tolerances of the shaft. To test the sealing function under extreme conditions, the maximum possible displacements of the shaft must be adapted to the test (for instance installed shaft offset of 0.1mm and dynamical runout of 0.1mm).

The test duration is defined in ISO 6194-4:2009-03 with 10 cycles of 24h duration each (each cycle with 14h normal operating shaft speed, 6h maximum operational shaft speed and 4h shutdown) or longer test duration as agreed between customer and supplier.

Typical post-test measurements are the diameters of the sealing and dust lip, the loss of radial force, the contact bandwidth at the sealing lip and appearance inspection mainly of the seal lip.

Acceptance criteria acc. ISO 6194-4:2009-03 is no visible leakage after 240h at least for 6 tested seals.



13.4 Durability Testing

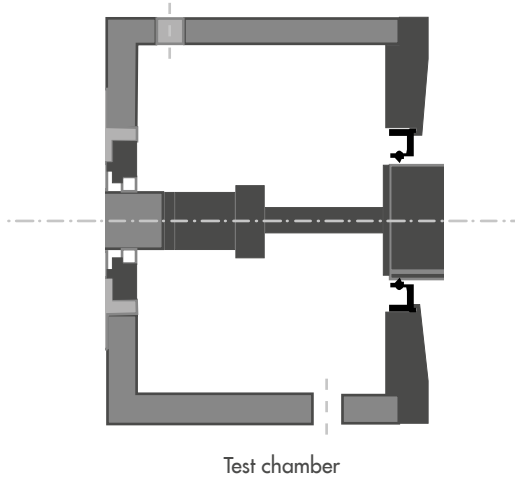

Exhibit 44 – Cross section view of test chamber

For durability testing the seal service life can be tested in the customer application according to a specific application profile or in a longterm dynamic test with similar test parameters as described in chapter 13.3. A typical test profile for durability is referred to as the “Flender test”. The test duration in that particular test profile is 1008h for FKM seals and 768h for NBR seals.

13.5 Functional and durability testing under dust and mud conditions

Under certain conditions rotary seals are exposed to harsh environmental conditions during operation. The dust protection of the sealing elements themselves is tested in especially designed test chambers. The test bench, similar to the one shown in chapter 13.4 is adapted to a mud chamber where dust and mud are applied to the seal area by a spray device

during seal operation. The typical mud mix is 24% percent in mass Arizona Test Dust acc. ISO 12103-1 + 76% in mass of water. Further parameters like speed, temperature, duration shall be set according to the application profile of the seal application.

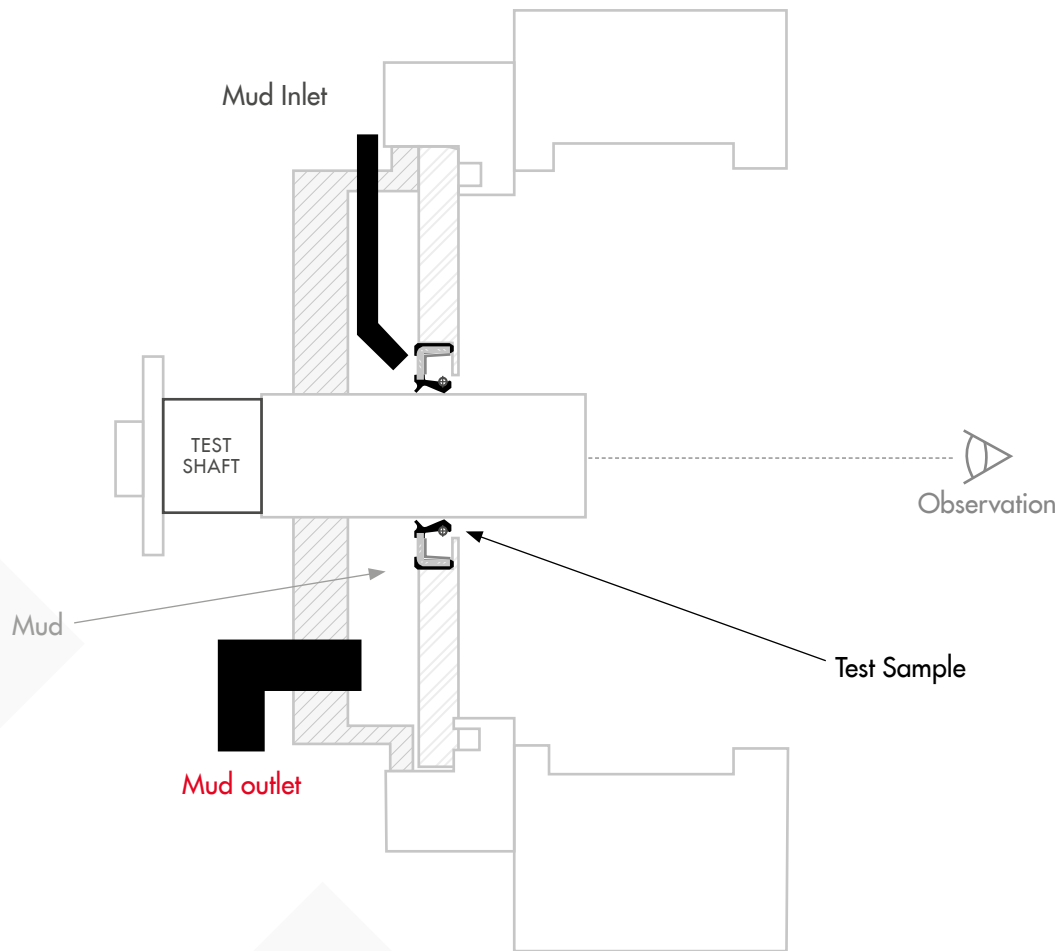

Exhibit 45 – Mud test bench principle for rotary shaft seals

13.6 Press Fit Test

Rotary seals are assembled as press fit to stay in place, generate sealing at the static sealing area and to support the friction torque of the dynamic sealing during the operation of the shaft. The press fit forces and the retaining force can be analyzed by the press fit test. Seals will be pressed in and out under extreme conditions (surface conditions, border tolerances of interference values at static sealing point, etc.)

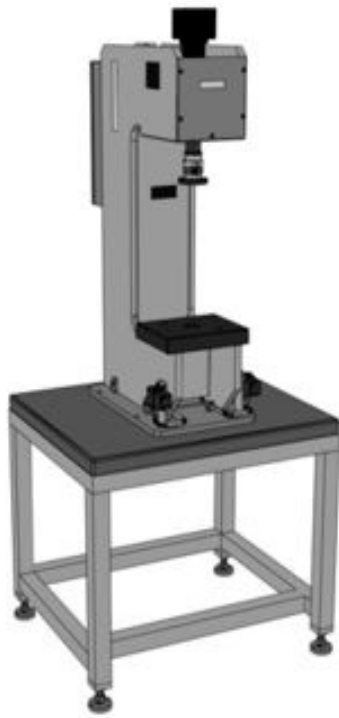

Exhibit 46 – Press fit test device

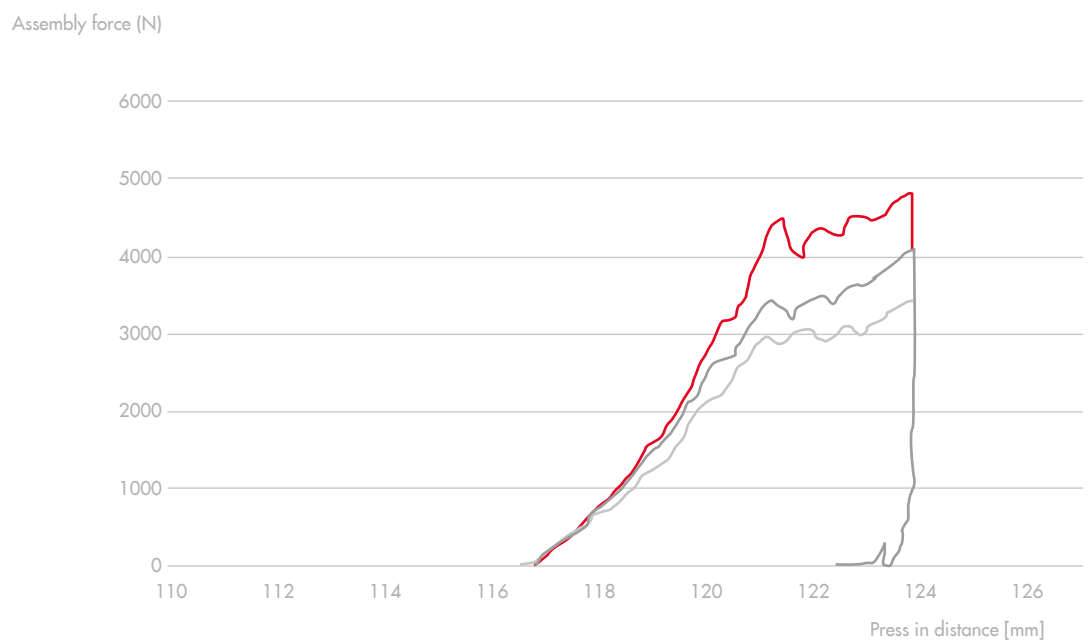

Exhibit 47 – Assembly force measurement

14. Storage

Storage according to Angst+Pfister Guidelines.



As some areas of the metal housing of rotary seals as well as garter springs are not protected against corrosion such seals have to be stored in corrosion protected conditions since metal case or garter springs are made of carbon steel.

15. Installation

15.1. Assembly of RRSS:

Assembly in housing

- Lead in chamfer housing, edges rounded
- Cohesion reduced if OD of RRSS lubricated with system oil
- Special agents that have a lubricating effect and increase cohesion are preferred.
- Hold the mounting force for some seconds to keep the seal in position (spring back effect).
- The outer seal may be damaged if friction is too high during assembly.

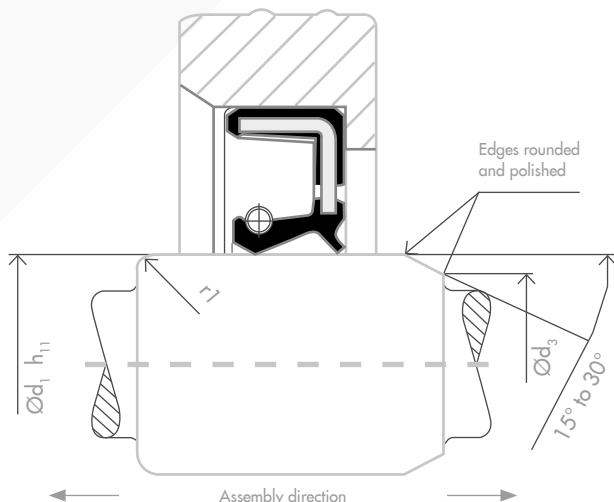

Exhibit 49 – Assembly of Seal onto shaft

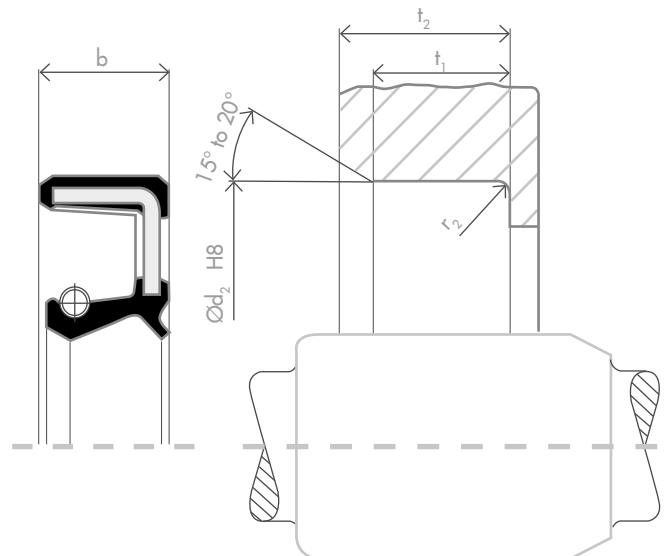

Exhibit 48 – Assembly of seal into housing bore

Assembly on shaft

- Lead in chamfer shaft according to sketch
- Lubrication of sealing lip / shaft is mandatory
- End of line air leakage test requires shaft rotation in advance



Method 1: Stop of RRSS in bore, face side first

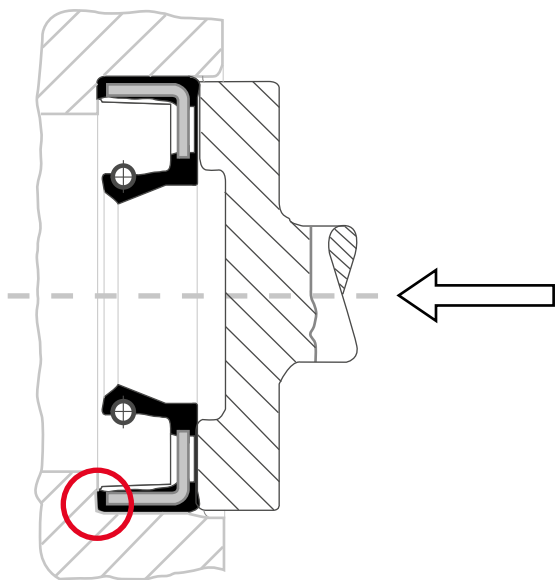

Exhibit 50 – Installation with press-in tool, stop in the bore

Method 2: Stop of RRSS by tool, face side first

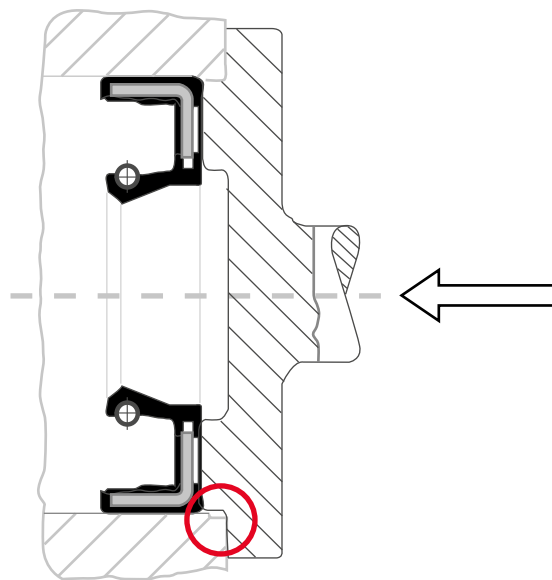

Exhibit 51 – Installation with press-in tool, stop on tool

Method 3: Stop of RRSS in bore, bottom side first

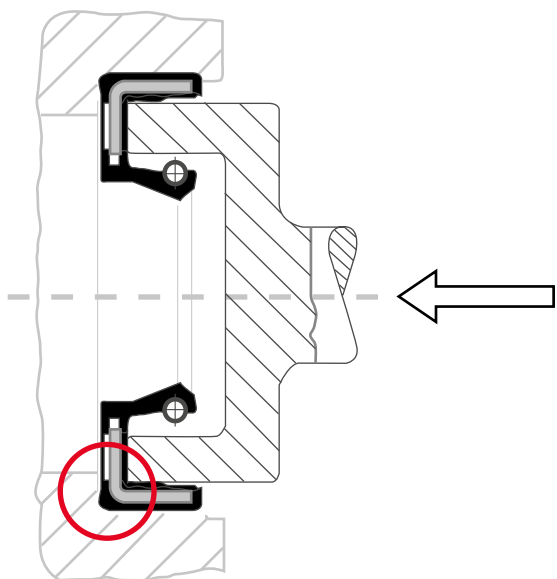

Exhibit 52 – Installation with press-in tool, bottom side first, stop in the bore

Method 4: Stop of RRSS by tool, bottom side first

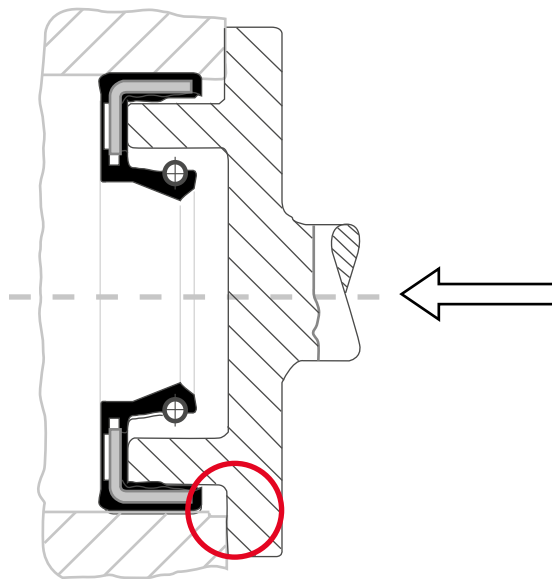
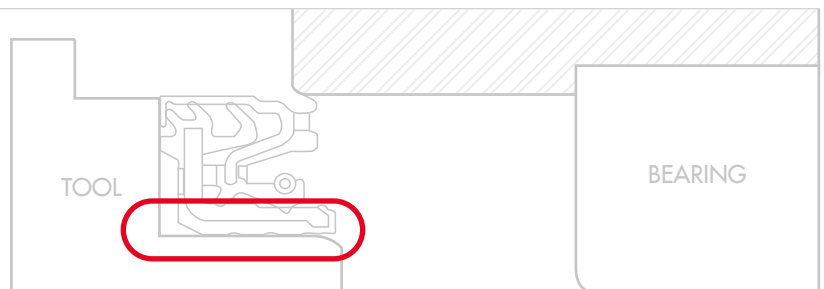

Exhibit 53 – Installation with press-in tool, bottom side first, stop on tool

15.2. Assembly of cassette seal, example:

INSTALLATION PROCESS

1. Pushing cassette seal on tool



2. Pushing seal into housing bore, stop by tool

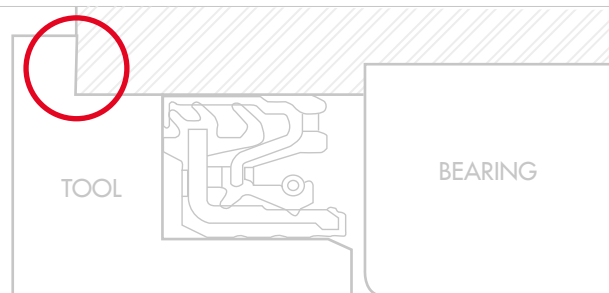

3. Removal of tool

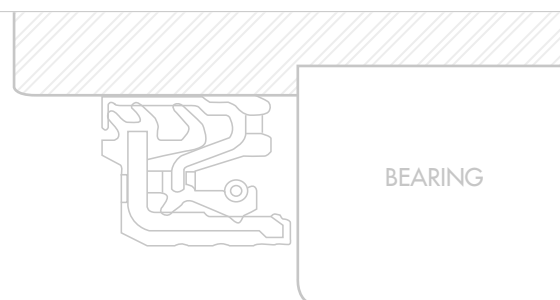

4. Mounting of sleeve, stop by sleeve against the bearing

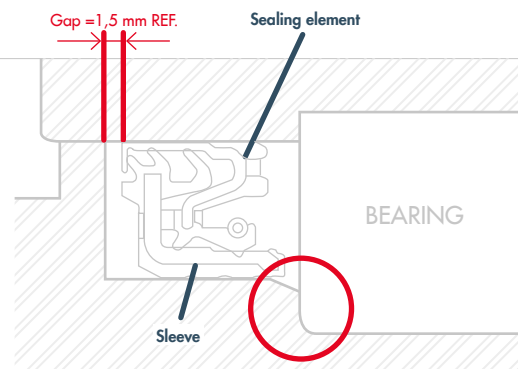

(Note: Customer can use this installation tool to control a gap between shaft side and flange of sealing element.)

Exhibit 54 – Assembly example for cassette seals

15.3 Disassembly and Replacement

Disassembly operations may damage shaft seals. If the seal has been in the testing phase it needs to be ensured to avoid deformation or damage during disassembly. (E.g. with screwdrivers, levers, etc.). Indeed, the physical characteristics of the seal resulting from the tests might be contaminated by this operation and not provide anymore useful data for further investigations.

It is always recommended to avoid reusing a seal after a disassembly operation. Furthermore, it is important to always ensure the new seals are installed in different sealing points/sliding areas along the shaft than the previous seals. If not possible, it is recommended to install a suitable shaft sleeve over the worn shaft and select a shaft seal with a proper internal diameter to fit the new shaft diameter.

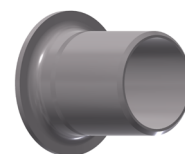
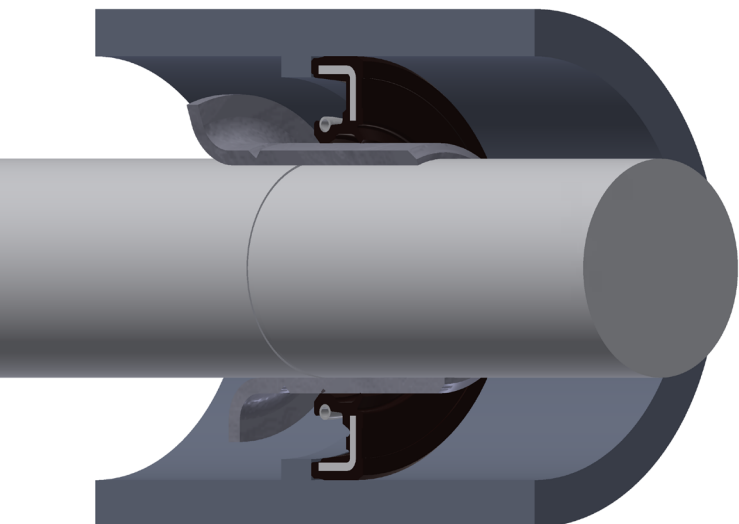

Exhibit 55 – Assembly view of shaft and rotary seal with sliding sleeve fixed on the shaft at the worn surface

16. Order Template



Customer & Division	Customer P/N	Contact	Material	Angst+Pfister
Telephone	Address	Date Required	Quality Control	
Annual Usage	Peak Month Usage	OEM	Design by	Customer Standard
		Aftermarket		Angst+Pfister
Application (Agricultural, Industrial...)	Equipment (Pump, Gearbox....)			Customer Sample
				Customer Drawing

Shaft	Material	Finish	Hardness		
Bore	Material	Finish	Hardness		
Temperature	Min.	Normal	Max.	°C	
				°F	
Pressure	Min.	Normal	Max.	°C	
				°F	
Media	Internal	Type	Brand and Grade	Dry	
				Flooded	
				Mist	
	External	Type			
Motion	Rotate				
	Min. RPM	Normal RPM	Max RPM		
	Run-Out	Shaft-To-Bore Misalignment	Axial-Movement		
	Direction From Air Side				
	C.W.	C.C.W.	Bi-Direction		
	Shaft Motion Direction				
	Horizontal	Vertical			
	Rotation Frequency				
	Continue	Intermittent			
	Reciprocate				
	Stroke Length	Cycles/Minute			
	Oscillate				
Arc Degree	Cycles/Minute				
Bearing	Ball or Roller bearing	Bushing			

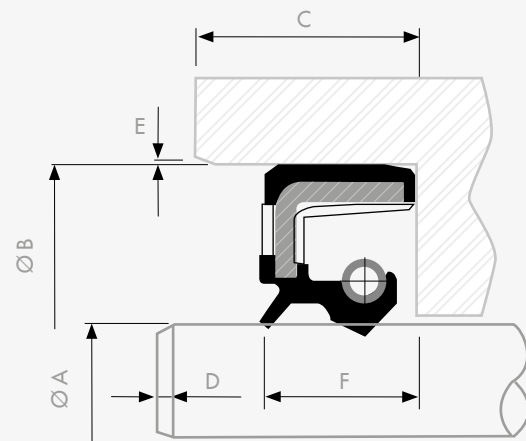

A. Shaft Diameter:

B. Bore Diameter:

C. Max Seal OD Width:

D. Shaft Chamfer & Angle:

E. Bore Chamfer & Angle:

F. Max Seal ID Width:

Special Requirements (Material, Test, Production Specification...)



17. Disclaimer

Pictures, Graphics, Illustrations and Animations:
© Copyright by Angst+Pfister 2022
Subject to alteration.

Support all over the world

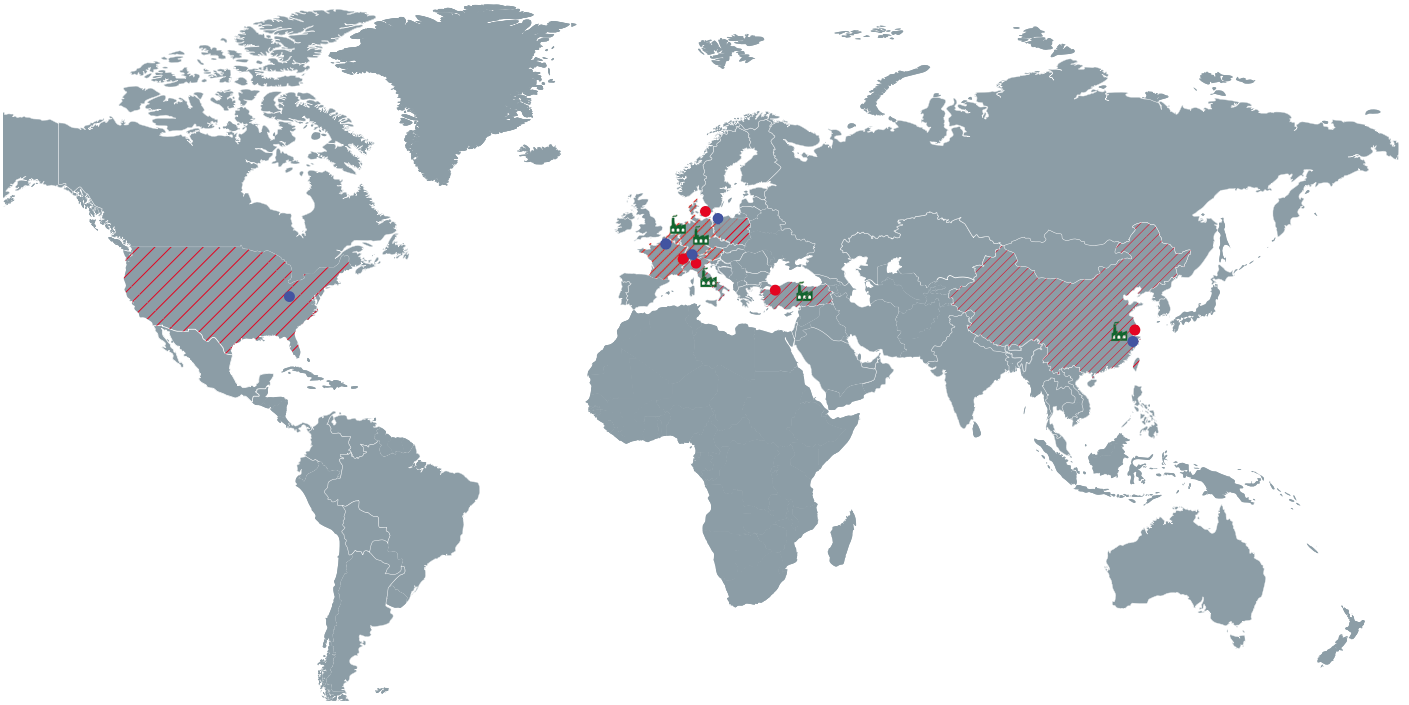

Angst+Pfister serves more than 20'000 customers per year in over 50 countries, through local sales and technical organizations supported by state-of-the-art engineering development centres.

-  Sales and engineering units
-  Development Centre
-  Global Logistics Centre
-  Production Site

If you have any questions, simply write to us:

info@angst-pfister.com

Simply scan with your smart-
phone or tablet and learn
more about Angst+Pfister

