

Static Electricity Prevention Equipment

Antistatic Equipment

Don't charge static electricity
(Conductivity)

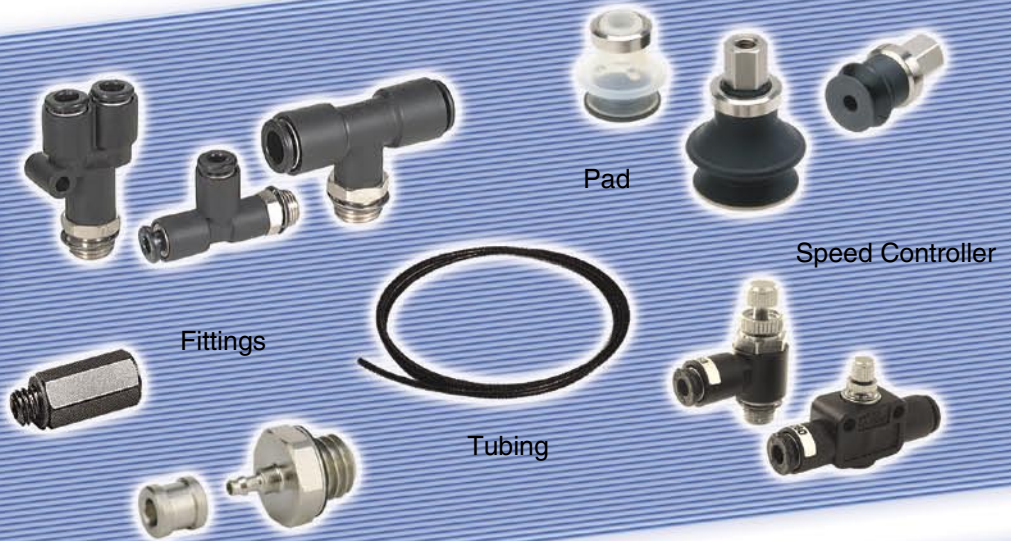

Electrostatic Removal Equipment

Eliminates static electricity
(Electrostatic removal)



Measurement Equipment

Confirms
(Confirmation)



SMC eliminates a variety of static

Prevents adhesion of foreign materials such as dust.
(Dust or particle removal)



Prevents electrostatic breakdown of electric parts.
(ESD)

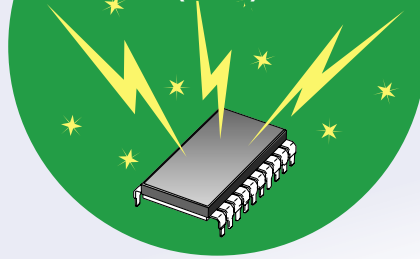

Prevents discomfort to electricians.
(Electric shock)



Measurement Equipment (Handheld)

Confirming electrostatic charge and removal of electricity

Handheld Electrostatic Meter P.27

Electrostatic Removal Equipment

Removing electricity by ionization

Ionizer P.18

Related Equipment P.24

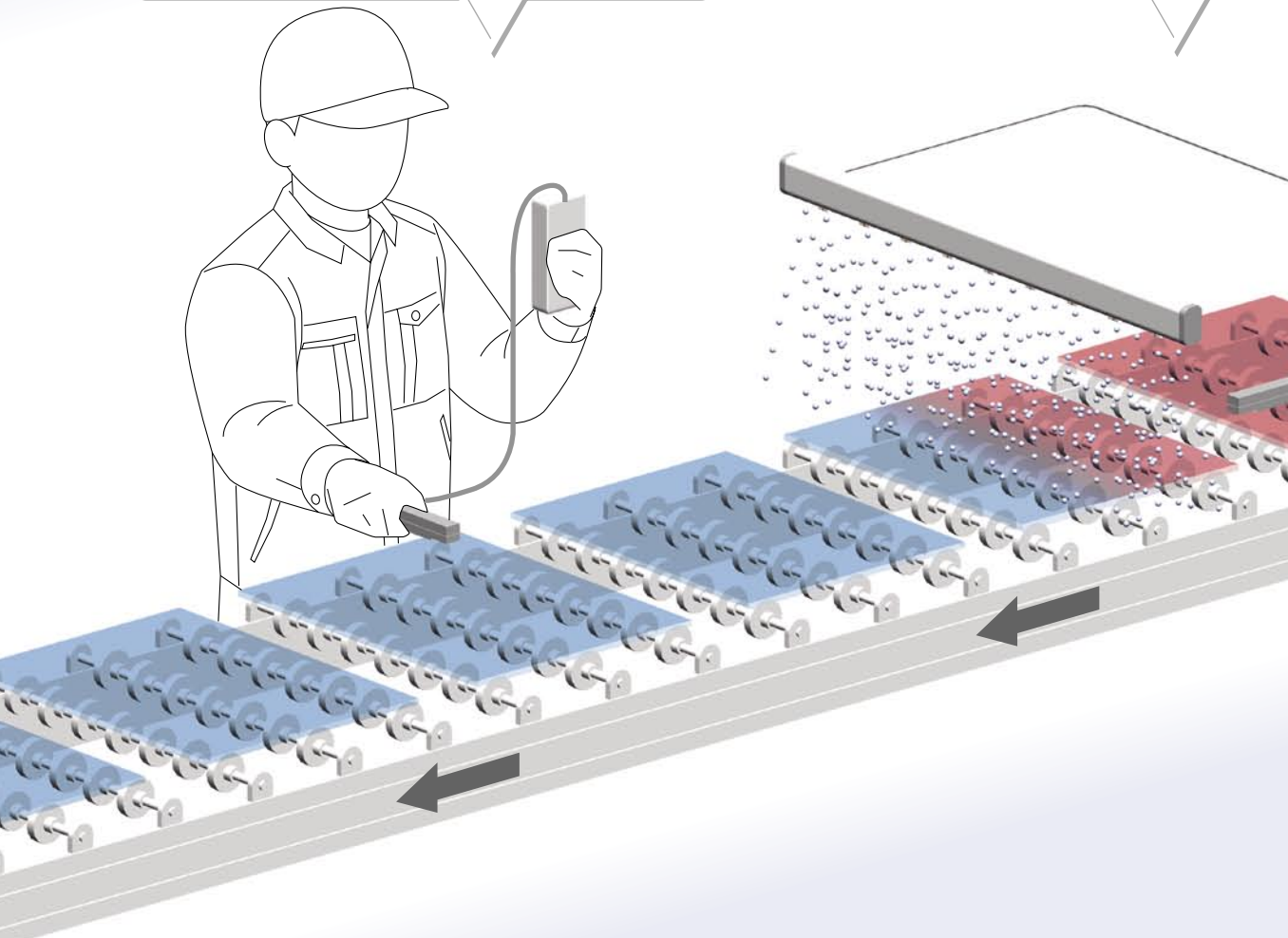

electricity generated problems.

Antistatic Equipment

Fittings P.3
Tubing P.8

Speed Controller
with One-touch Fitting P.10

Vacuum Pad P.12
Antistatic Air Cylinder P.17

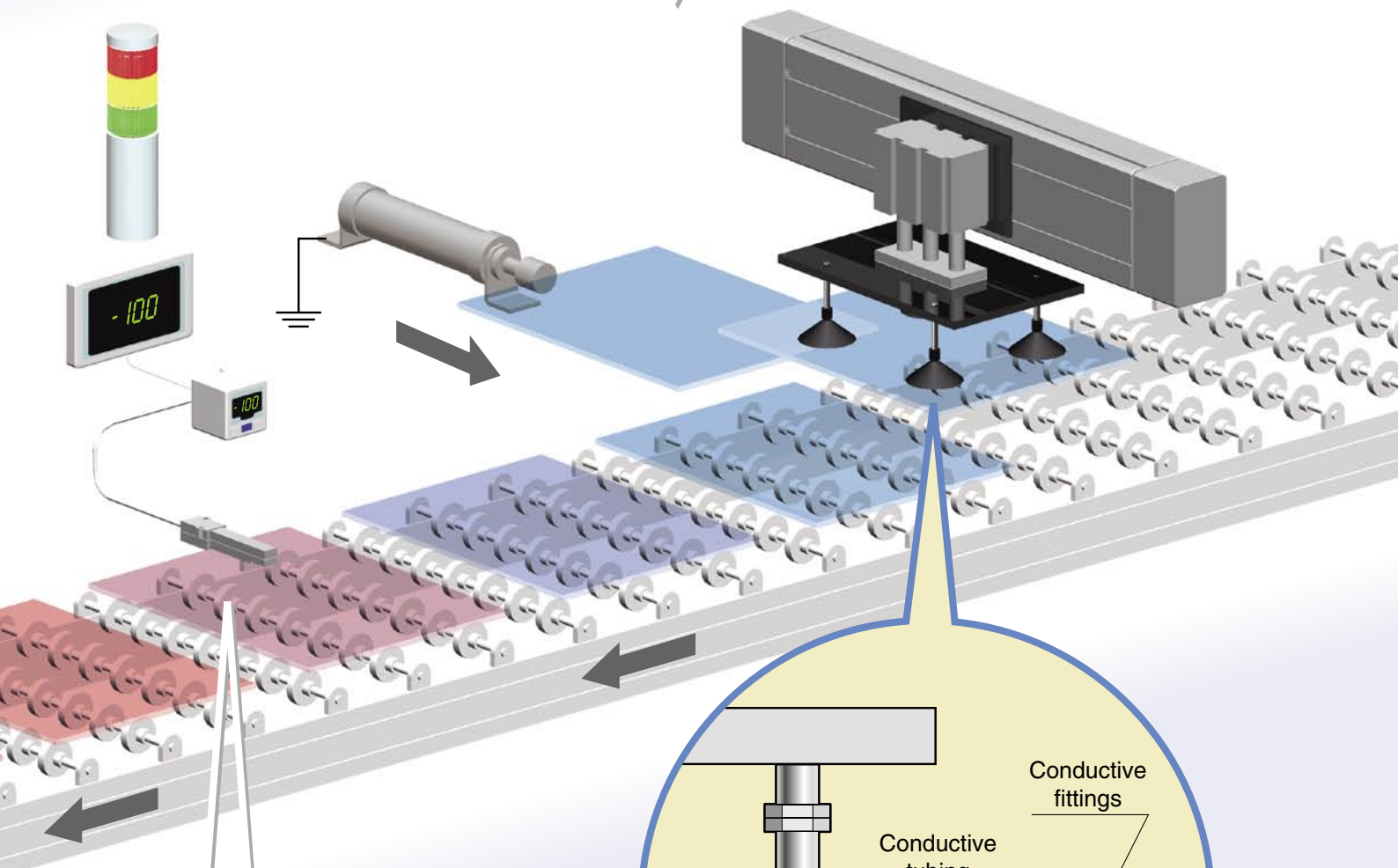

Measurement Equipment (for FA Devices)

Measuring amount of electrostatic charge of a workpiece.

- Confirming electrostatic condition of a workpiece.
- Checking quality

Electrostatic Sensor P.25

Examples of Static Electricity Generated Problem

Absorbing multiple sheets

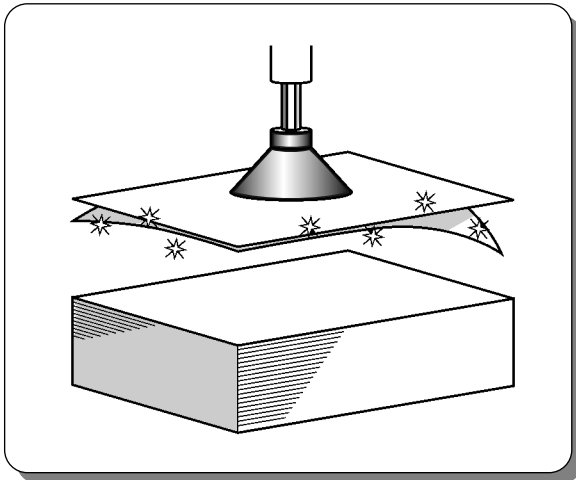

Clogging of parts feeders

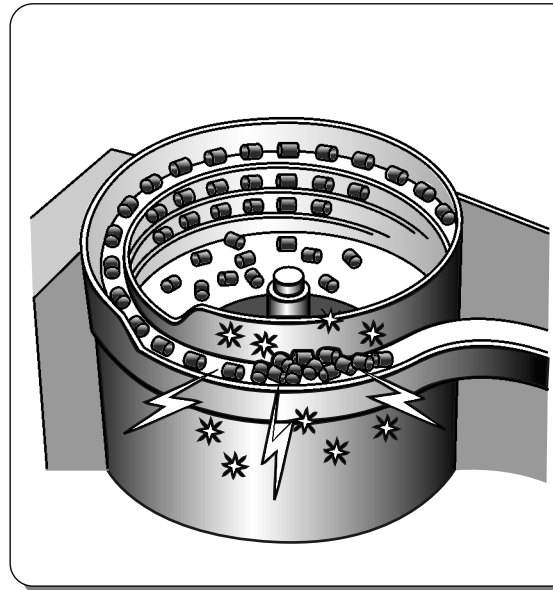

Electrostatic breakdown of substrate and IC chips

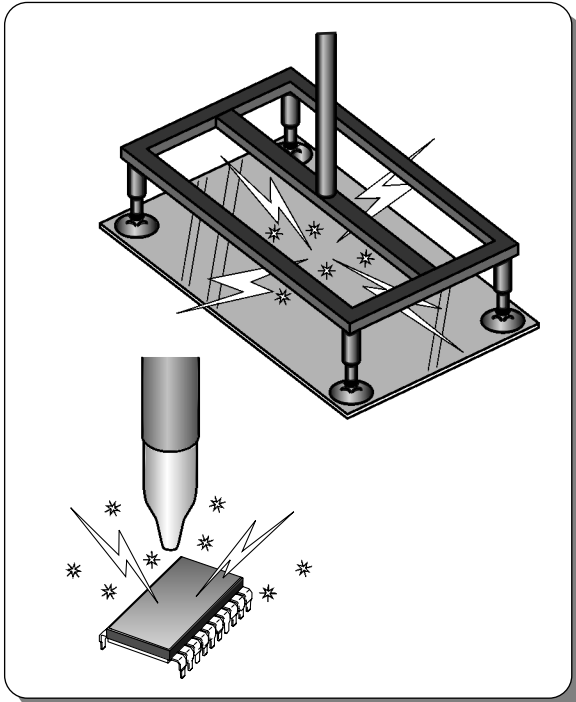

Failures while ejecting workpieces from unloader

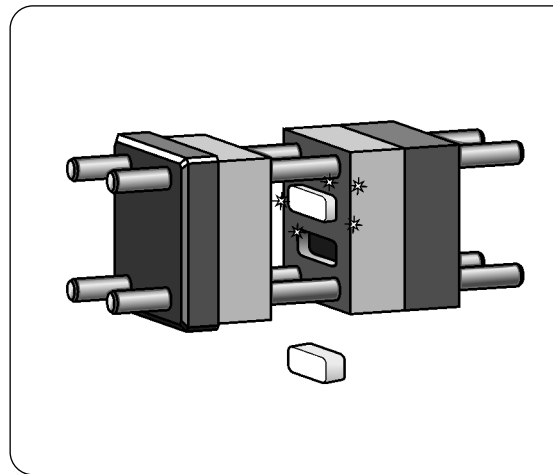

Discomfort due to electrical shocks at workplace



Uneven painting

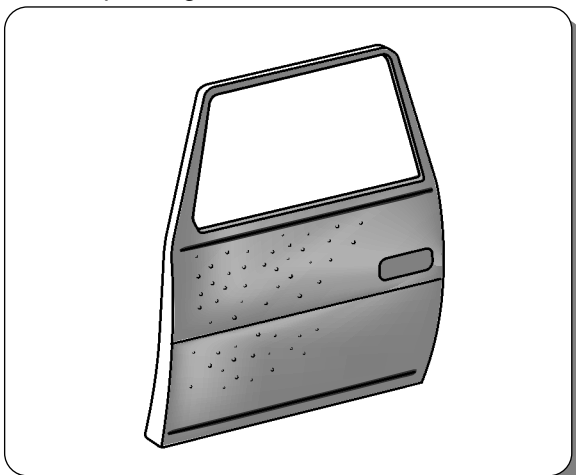

Antistatic Equipment

Lineup of products with conductivity prevention

Friction, contact and detachment cause the build up of static electricity. Static electricity can be instantaneously removed from metals with low volume resistance (conductors) by grounding. Resin and rubber (insulators) which have high volume resistance, however, build up static electricity as it is not eliminated even through grounding. Charged substances cause various problems such as the destruction of devices by electrical discharge, dust adhesion, and the like. Hence, SMC has a lineup of products to which conductive resin and rubber are applied in order to remove static electricity.

SMC's conductive resin and rubber incorporates the following volume resistance materials.

Volume Resistance ($\Omega \cdot m$) for Reference

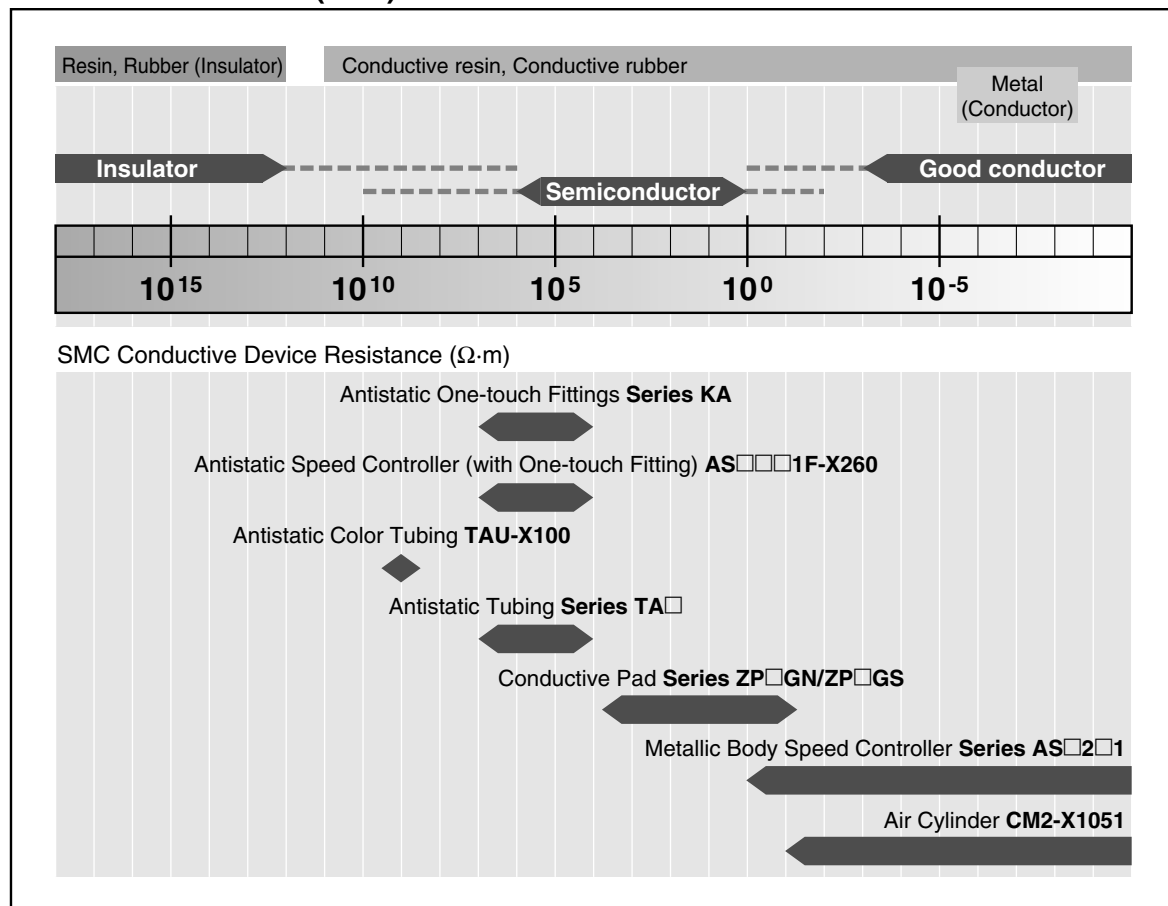

For reference: The following table shows the electric resistance and characteristics of major materials.

Materials	Electric resistance	Characteristics
Resin, Rubber (Insulator)	10^{12} to 10^{18} $\Omega \cdot m$	Some static electricity does not attenuate after charging. Grounding is not useful.
Conductive resin, Conductive rubber	10^{11} $\Omega \cdot m$ or less	It is possible to remove static electricity by seconds after grounding.
Metal (Conductor)	10^0 $\Omega \cdot m$ or less	Static electricity can be instantaneously removed by grounding.

Antistatic Equipment INDEX

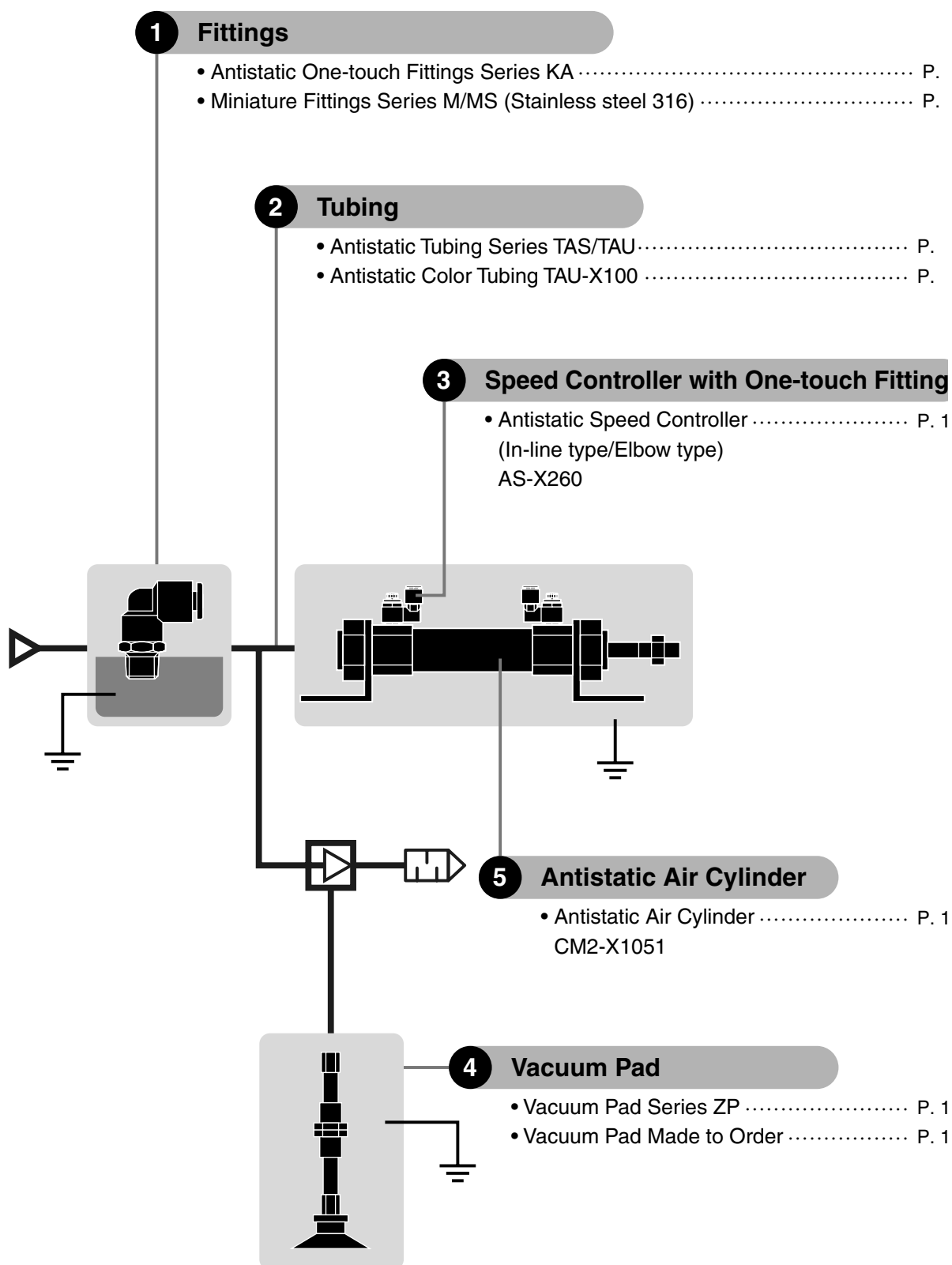

Antistatic One-touch Fittings Series KA

- Possible to use from vacuum (−100 kPa)
- Can be used in copper-free application.
- Surface resistance 10^4 to $10^7 \Omega$
- Conductive resin is used for body and seals in fittings and tubing.



Seal

Can be used for a wide range of pressures from low vacuum up to a pressure of 1.0 MPa.

The use of a special profile ensures sealing and reduces resistance when the tube is inserted.

Chuck

Large retaining force

Has large retaining force while holding force is increased by the collet.

Collet

Guide

Body (Black)

O-ring

Stud

Effective when piping in a confined space.

The body and the threaded portion can rotate (to the degree for positioning).

Gasket

UNI Thread

Release Button (Black)

Light force for removal

When the fitting is removed from the tubing, the check and collet are released, thus preventing them from biting into the tube excessively.

Grounding Method

When UNI thread screws are used metal contact occurs between female and male threads and the fittings do not become electro-statically charged. (With taper threaded screws it is necessary to apply a sealant to the thread, which electrically insulates the fittings causing it to become charged.)

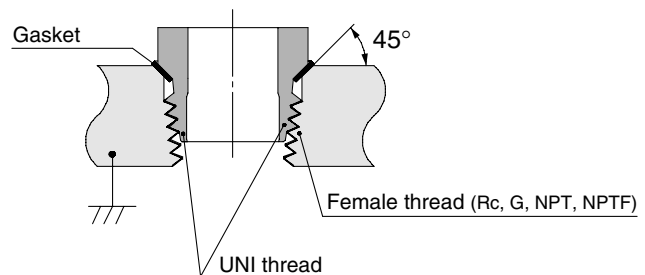

Figure: UNI thread ridge profile

⚠ Caution (Chamfer the female thread.)

Main Parts Material

Body	C3604BD, PBT
Stud	C3604BD
Chuck	Stainless steel 304
Guide	Stainless steel 304, C3604BD, PBT
Collet, Release button	PBT
Seal, O-ring	NBR

- C3604BD is all electroless nickel plated.
- PBT parts have conductive (10^4 to $10^7 \Omega$) and flame resistant applications. (equivalent to UL Standard V-0)
- Conductive NBR (10^4 to $10^7 \Omega$) is used for seals.

Size of female thread chamfering (Recommended values)

Chamfering in accordance with the following table improves thread workability and prevents the occurrence of burrs.

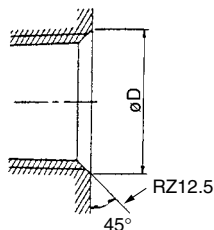

Female thread size	Chamfering bore øD (Recommended value)		
	G	Rc	NPT, NPTF
1/8	10.2 to 11.5	10.2 to 11.8	10.5 to 11.8
1/4	13.6 to 14.5	13.6 to 15.8	14.1 to 15.8
3/8	17.1 to 18.5	17.1 to 19.4	17.4 to 19.4
1/2	21.4 to 22.5	21.4 to 25.1	21.7 to 25.1

Applicable Tubing

Tubing material	Antistatic soft nylon, Antistatic polyurethane
Tubing O.D.	ø3.2, ø4, ø6, ø8, ø10, ø12





Specifications

Fluid	Air
Operating pressure range	−100 kPa to 1 MPa
Proof pressure	3 MPa
Ambient and fluid temperature	0 to 40°C
Thread	UNI thread
	JIS B0205, Class 2 (Metric coarse thread)
Seal (Thread portion)	Gasket
Copper-free	Brass parts are all electroless nickel plated.
Surface resistance	10^4 to $10^7 \Omega$

Male Connector

KAH

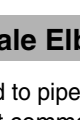
Used to pipe in the same direction from female threaded portion
Most common type

	Applicable tubing O.D. (mm)	Connection thread	Model
	3.2	M5 x 0.8	KAH23-M5
		M6 x 1	-M6
		Uni 1/8	-U01
	4	M5 x 0.8	KAH04-M5
		M6 x 1	-M6
		Uni 1/8	-U01
		Uni 1/4	-U02
	6	M5 x 0.8	KAH06-M5
		M6 x 1	-M6
		Uni 1/8	-U01
		Uni 1/4	-U02
	8	Uni 1/8	KAH08-U01
		Uni 1/4	-U02
		Uni 3/8	-U03
	10	Uni 1/8	KAH10-U01
		Uni 1/4	-U02
		Uni 3/8	-U03
		Uni 1/2	-U04
	12	Uni 1/4	KAH12-U02
		Uni 3/8	-U03
		Uni 1/2	-U04







<M5, M6>

<UNI thread>

Male Branch Tee

KA

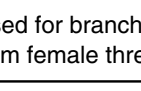
Used for branching from a female threaded portion
both sides

	Applicable tubing O.D. (mm)	Connection thread	Model
	3.2	M5 x 0.8	KAT23
		M6 x 1	
		Uni 1/8	
	4	M5 x 0.8	KAT04
		M6 x 1	
		Uni 1/8	
		Uni 1/4	
	6	M5 x 0.8	KAT06
		M6 x 1	
		Uni 1/8	
		Uni 1/4	
	8	Uni 1/8	KAT08
		Uni 1/4	
		Uni 3/8	
	10	Uni 1/8	KAT10
		Uni 1/4	
		Uni 3/8	
		Uni 1/2	
	12	Uni 1/4	KAT12
		Uni 3/8	
		Uni 1/2	





<M5, M6>

<UNI thread>

Male Elbow

KAL

Used to pipe in the same direction from female threaded portion
Most common type

	Applicable tubing O.D. (mm)	Connection thread	Model
	3.2	M5 x 0.8	KAL23-M5
		M6 x 1	-M6
		Uni 1/8	-U01
	4	M5 x 0.8	KAL04-M5
		M6 x 1	-M6
		Uni 1/8	-U01
		Uni 1/4	-U02
	6	M5 x 0.8	KAL06-M5
		M6 x 1	-M6
		Uni 1/8	-U01
		Uni 1/4	-U02
	8	Uni 1/8	KAL08-U01
		Uni 1/4	-U02
		Uni 3/8	-U03
	10	Uni 1/8	KAL10-U01
		Uni 1/4	-U02
		Uni 3/8	-U03
		Uni 1/2	-U04
	12	Uni 1/4	KAL12-U02
		Uni 3/8	-U03
		Uni 1/2	-U04





<M5, M6>

<UNI thread>

Male Run Tee

KA

Used for branching into the same direction and at 90°
from female threaded portion

	Applicable tubing O.D. (mm)	Connection thread	Model
	3.2	M5 x 0.8	KAY23
		M6 x 1	
		Uni 1/8	
	4	M5 x 0.8	KAY04
		M6 x 1	
		Uni 1/8	
		Uni 1/4	
	6	M5 x 0.8	KAY06
		M6 x 1	
		Uni 1/8	
		Uni 1/4	
	8	Uni 1/8	KAY08
		Uni 1/4	
		Uni 3/8	
	10	Uni 1/8	KAY10
		Uni 1/4	
		Uni 3/8	
		Uni 1/2	
	12	Uni 1/4	KAY12
		Uni 3/8	
		Uni 1/2	

<M5, M6>

<UNI thread>

Antistatic Equipment

Antistatic One-touch Fittings Series KA

Male Branch Y

KAU

Used for branching from a female threaded portion into the same direction

	Applicable tubing O.D. (mm)	Connection thread	Model
<M5, M6>	3.2	M5 x 0.8	KAU23-M5
		M6 x 1	-M6
		Uni 1/8	-U01
	4	M5 x 0.8	KAU04-M5
		M6 x 1	-M6
		Uni 1/8	-U01
		Uni 1/4	-U02
	6	M5 x 0.8	KAU06-M5
		M6 x 1	-M6
		Uni 1/8	-U01
		Uni 1/4	-U02
		Uni 3/8	-U03
	8	Uni 1/8	KAU08-U01
		Uni 1/4	-U02
		Uni 3/8	-U03
	10	Uni 1/4	KAU10-U02
		Uni 3/8	-U03
<UNI thread>	12	Uni 1/2	-U04
		Uni 1/4	KAU12-U02
		Uni 3/8	-U03

Union Tee

KAT

Used for branch connections of tubes into two directions at 90° on both sides

	Applicable tubing O.D. (mm)	Model
	3.2	KAT23-00
4	KAT04-00	
6	KAT06-00	
8	KAT08-00	
10	KAT10-00	
12	KAT12-00	

Union Y

KAU

Used to branch a tubing in the same direction

	Applicable tubing O.D. (mm)	Model
	3.2	KAU23-00
4	KAU04-00	
6	KAU06-00	
8	KAU08-00	
10	KAU10-00	
12	KAU12-00	

Straight Union

KAH

Used to connect tubes in the same direction

	Applicable tubing O.D. (mm)	Model
	3.2	KAH23-00
4	KAH04-00	
6	KAH06-00	
8	KAH08-00	
10	KAH10-00	
12	KAH12-00	

Different Dia. Straight Union

KAH

Used to connect different size tubes

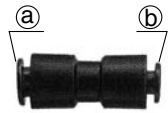
	Applicable tubing O.D. (mm)		Model
	①	②	
	3.2	4	KAH23-04
	4	6	KAH04-06
	6	8	KAH06-08
	8	10	KAH08-10
	10	12	KAH10-12

Elbow

KAL

Used to connect tubes at right angles

	Applicable tubing O.D. (mm)	Model
	3.2	KAL23-00
4	KAL04-00	
6	KAL06-00	
8	KAL08-00	
10	KAL10-00	
12	KAL12-00	

Plug-in Reducer

KAR

Used to change the diameter of one-touch fitting

	Applicable tubing O.D. (mm)	Applicable fitting size	Model
	3.2	4	4
6			KAR04-06
8			-08
4	6	10	-10
		8	KAR06-08
		10	-10
6	8	12	-12
		10	KAR08-10
		12	-12
8	10	12	-12
		12	KAR10-12
10	12	KAR10-12	

Miniature Fittings Series M/MS (Stainless steel 316)

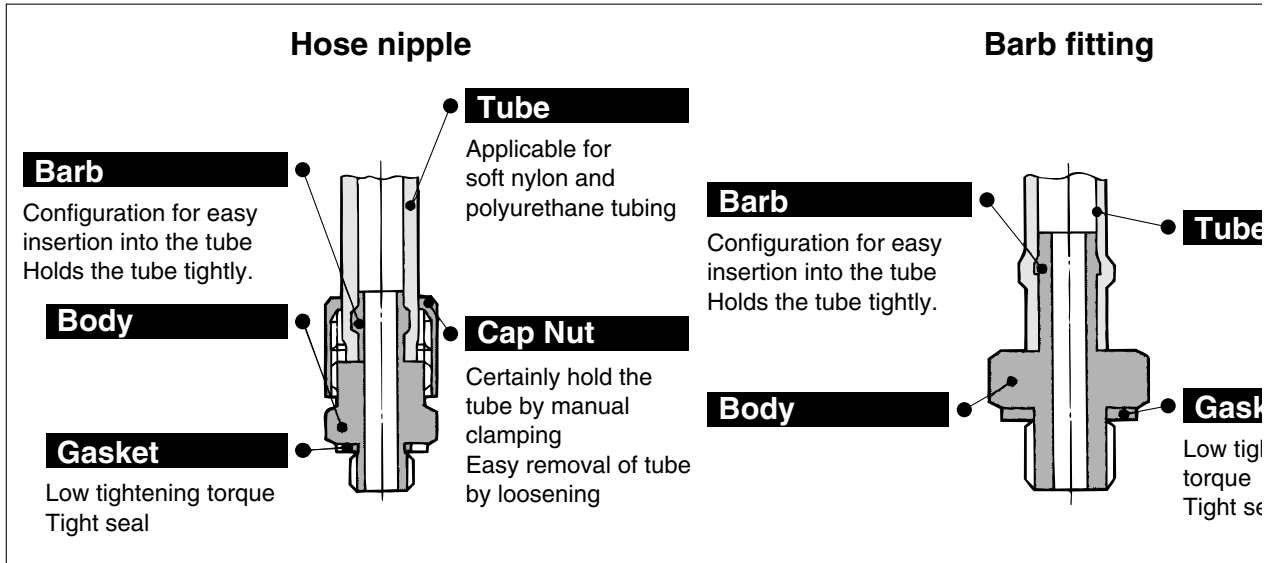

Compact piping space
Hose nipple tubing connection/disconnection is simple while keeping a large retaining force.

Line up various styles
For air connection in confined areas

Hose nipple, Hose fitting
Applicable for soft nylon and polyurethane tubing

Series M



Specifications

Applicable tubing material	Soft nylon <small>Note1)</small>		Polyurethane
	M3	ø3.18/ø2.18	ø4/ø2.5
M5-R 1/8	ø4/ø2.5 ø6/ø4		ø3.18/ø2 ø4/ø2.5, ø6/ø4, ø8/ø4
Max. operating pressure (at 20°C)	1 MPa		0.8 MPa
Connection size	M3, M5, R 1/8		
Thread	Metric thread (JIS B0205 Class 2), Pipe thread (ø)		
Fluid	Air, Water <small>Note2)</small>		
Ambient and fluid temperature	-50 to 60°C Water: 0 to 40°C (with no freeze)		

Note 1) Water is not available with soft nylon tubing
Note 2) Available with hose nipple type

Main Parts Material

Material	Body	Gasket
	C3604BD (Nipple M-3N, M-5N: Stainless steel)	PVC, Stainless steel 304, NBR

Series MS (Stainless steel 316)



Specifications

Applicable tubing material	Soft nylon <small>Note1)</small>		Polyurethane
	Applicable tubing O.D./I.D.	ø3.18/ø2.18	ø4/ø2.5 ø6/ø4
Max. operating pressure (at 20°C)	1 MPa		
Connection size	M5 (JIS B0205 Class 2: Metric coarse thread)		
Fluid	Air, Water <small>Note2)</small>		
Ambient and fluid temperature	-50 to 60°C Water: 0 to 40°C (with no freeze)		

Note 1) Water is not available with soft nylon tubing
Note 2) Available with hose nipple type

Main Parts Material













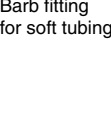









Material	Body	Gasket
	Stainless steel 316	PVC

Antistatic Equipment

Miniature Fittings *Series M/MS*

Caution

Although there are other miniature fittings in the General Catalog, they are not designed for antistatic applications. Only the following are available.

Series M					Series MS								
Series	Model	Description	Application	Note	Series	Model	Description	Application	Note	Model	Description	Application	Note
M3	M-3AU-2	Barb fitting for soft tubing 	For polyurethane tubing	ø2/ø1.2 x M3	M5	M-5L	Elbow 	One-sided 90° elbow	M5 female x M5 female	MS-5AU-3	Barb fitting for soft tubing 	For soft nylon tubing	ø3.18 x ø2.18 x M5
	M-3AU-3	Barb fitting for soft tubing 	For soft nylon tubing	ø3.18/2.18 x M3		M-5T	Tee 	Both sides allow 90° connection	M5 female x M5 female x M5 female	MS-5AU-4	For polyurethane tubing 	For soft nylon and polyurethane tubing	ø4/ø2.5 x M5
	M-3AU-4	For polyurethane tubing	ø3.18/2 x M3	M-5J		Extension fitting 	Solid piece moves fitting up from workpiece.	M5 male x M5 female	MS-5AU-6	For soft nylon and polyurethane tubing	ø6/ø4 x M5		
	M-3N	Nipple 	Fitting to workpiece and fitting to fitting connection	M3 male x M3 male		M-5N	Nipple 	Fitting to workpiece and fitting to fitting connection	M5 male x M5 male	MS-5H-4	Hose nipple 	For soft nylon and polyurethane tubing	ø4/ø2.5 x M5
	M-3P	Plug 	Use to plug unused M3 port.			M-5UN	Universal nipple 	Body rotates at 360° around the stud axis.	M5 male x M5 male PAT.	MS-5H-6	For soft nylon and polyurethane tubing	ø6/ø4 x M5	
	M-5AU-2	Barb fitting for soft tubing 	For polyurethane tubing	ø2/ø1.2 x M5		M-5E	Bulkhead union 	Panel mount connection	M5 female x M5 female	MS-5J	Extension fitting 	Solid piece moves fitting up from workpiece.	M5 male x M5 female
M5	M-5AU-3	Barb fitting for soft tubing 	For soft nylon tubing	ø3.18/2.18 x M5	M-5ER	Bulkhead reducer 	Reduction from Rc 1/8 to M5 including panel or bracket mounting	Rc1/8 x M5 female	MS-5N	Nipple 	Fitting to workpiece and fitting to fitting connection	M5 male x M5 male	
	M-5AU-4	For polyurethane tubing	ø3.18/2 x M5	M-5M	Manifold 	For reducing Rc 1/8 female be diverted to up to 9, M5 stations, including panel or bracket mounting	Rc 1/8 x M5 female (9 stations)	MS-5UN	Universal nipple 	Body rotates at 360° around the stud axis.	M5 male x M5 male PAT.		
	M-5AU-6	For soft nylon and polyurethane tubing	ø6/4 x M5	M-5P	Plug 	Use to plug unused M5 port.							
	M-5H-4	Hose nipple 	For soft nylon and polyurethane tubing	ø4/2.5 x M5									
	M-5H-6	For soft nylon and polyurethane tubing	ø6/4 x M5										

Antistatic Tubing *Series TAS/TAU*

Antistatic Soft Nylon Tubing / Series TAS

Flame resistant
(equivalent to UL 94
Standard V-0)
 10^4 to $10^7 \Omega$



Series

● —20 m roll

Model	TAS3222	TAS0425	TAS0604	TAS0805	TAS1065
Tubing O.D. (mm)	3.2	4	6	8	10
Tubing I.D. (mm)	2.2	2.5	4	5	6.5

Black (B)	●	●	●	●	●
-----------	---	---	---	---	---

Specifications

Max. operating pressure (at 20°C)	1.2 MPa				
Burst pressure	Refer to the burst pressure characteristics curve				
Min. bending radius (mm)	12	12	15	19	27
Operating temperature	0 to 40°C				
Material	Conductive nylon + Flame resistant nylon (equivalent to UL 94)				
Surface resistance	10^4 to $10^7 \Omega$				

Burst Pressure Characteristics Curve and Operating Pressure

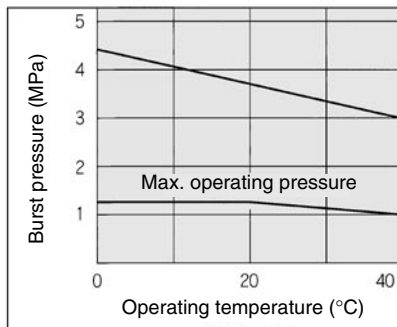

How to Order

TAS1065 **B** — **100**

Tubing designation

Symbol	Color
B	Black

Length per roll

Symbol	Length
20	20 m roll
100	100 m reel

Made to Order



Coil tubing

Antistatic Polyurethane Tubing / Series TAU

Soft type
 10^4 to $10^7 \Omega$



Series

●—20 m roll □—100 m reel

Model	TAU3220	TAU0425	TAU0604	TAU0805	TAU1065	TAU1208
Tubing O.D. (mm)	3.2	4	6	8	10	12
Tubing I.D. (mm)	2	2.5	4	5	6.5	8

Color	TAU3220	TAU0425	TAU0604	TAU0805	TAU1065	TAU1208
Black (B)	●	●	●	●	●	●

Specifications

Max. operating pressure (at 20°C)	0.9 MPa					
Burst pressure	Refer to the burst pressure characteristics curve.					
Min. bending radius (mm)	10	10	15	20	27	35
Operating temperature	0 to 40°C					
Material	Conductive polyurethane					
Surface resistance	10^4 to $10^7 \Omega$					

Burst Pressure Characteristics Curve and Operating Pressure

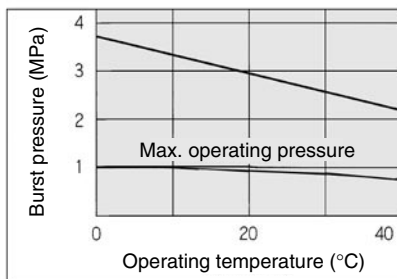

How to Order

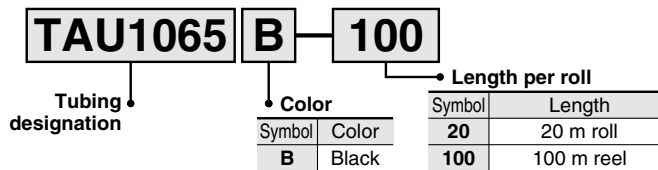

Made to Order



Antistatic Polyurethane Tubing / -X100

Made to Order

- 5 colors
- Surface resistance $10^9 \Omega$

Specifications

Fluid	Air
Max. operating pressure (at 20°C)	0.8 MPa
Ambient and fluid temperature	0 to 40°C
Material	Antistatic polyurethane
Surface resistance	$10^9 \Omega$
Recommended fittings	Antistatic one-touch fittings: Series KA Miniature fittings: Series M/MS (Note)

Note) Miniature fittings: The following models of the M/MS series are only available.

Series M	Series MS
M-3AU-2	MS-5AU-4
M-3AU-4	MS-5AU-6
M-5AU-2	MS-5H-4
M-5AU-4	MS-5H-6
M-5AU-6	
M-5H-4	
M-5H-6	

How to Order

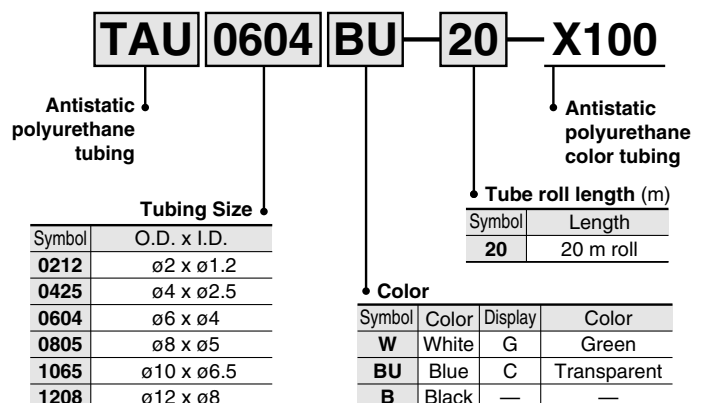

Antistatic Speed Controller (In-line type/Elbow type)

AS-X260

Made to Order

Electrostatic prevention measures for semiconductor manufacturing devices, etc.

It is possible to prevent products from being electro-statically charged by applying conductive materials (using conductive NBR seal) and grounding UNI thread structure*1) (Gasket seal method).



*1) Ensure that the female thread connected to the speed controller is grounded. If not grounded, there is a possibility that the controller and tube may remain charged. Antistatic tubes should also be used.

Feature 1: Surface Resistance 10^4 to $10^7 \Omega$ (Conductive material is applied to the body seal of the c

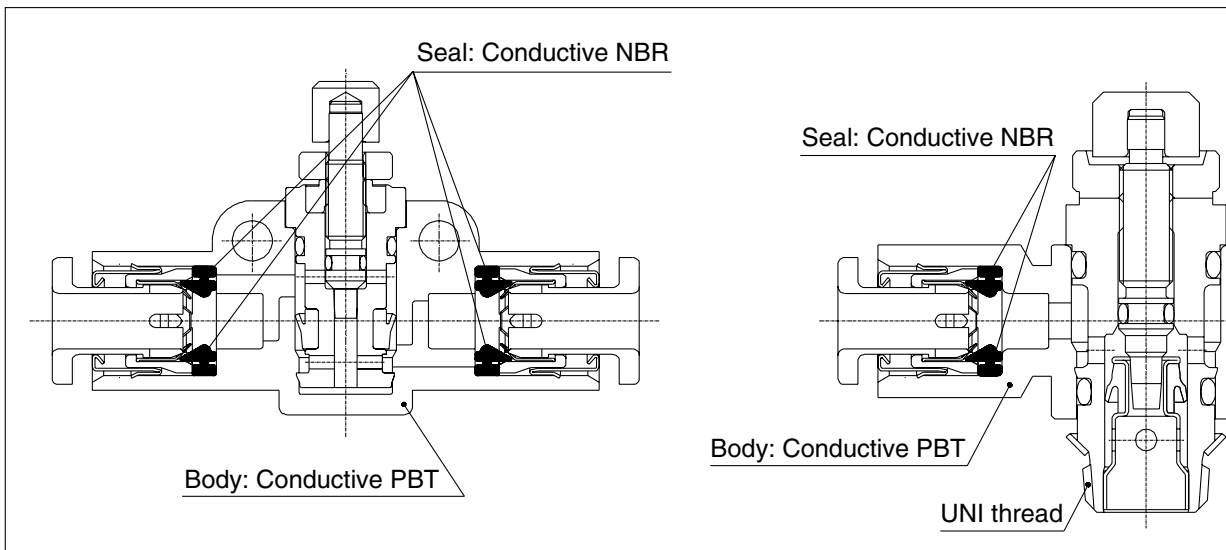

Features 2: Antistatic UNI Thread Structure (Gasket seal method) (AS22□1F-□-□-X260 type)

Grounding Method

When UNI thread screws are used metal contact occurs between female and male threads and the controller does not become electrostatically charged. (With taper threaded screws it is necessary to apply a sealant to the thread, which electrically insulates the controller causing it to become charged.)

Specifications

Common Specifications

Type	Elbow	In-line
Model	AS□2□1F-□-□-X260	AS□000F-□-□-X260
Fluid	Air	
Proof pressure	1.5 MPa	1 MPa
Maximum operating pressure	1 MPa	0.7 MPa
Minimum operating pressure	0.1 MPa	
Ambient and fluid temperature	-5 to 60°C (with no freezing)	
Number of needle rotations	10 rotations *2	8 rotations
Applicable tubing material	Antistatic soft nylon tubing (Series TAS) Antistatic polyurethane tubing (Series TAU)	
Surface resistance	10^4 to $10^7 \Omega$	

*2) 8 rotations for AS12□1F-M5-04-X260 and AS12□1F-M5-06-X260

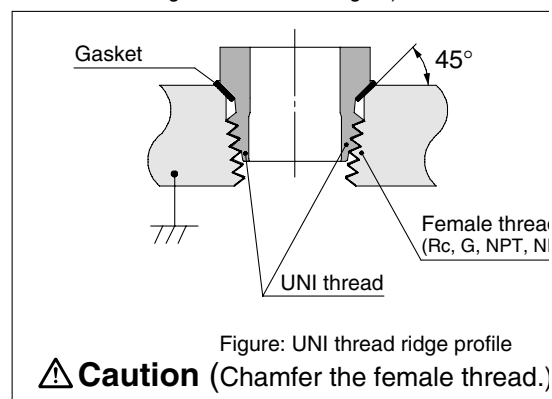

Series Variation

Type	Model		Port size	Applicable tubing O.D.				Applicable bore size
	Meter-out	Meter-in		4	6	8	10	
Elbow	AS1201F-M5	AS1211F-M5	M5 x 0.8	●	●			6, 10,
	AS2201F-U01	AS2211F-U01	Uni1/8	●	●	●	●	20, 25,
	AS2201F-U02	AS2211F-U02	Uni1/4	●	●	●	●	20, 25,
In-line	AS1000F		—	●	●			6, 10,

*3) Contact SMC for models other than the above.

*4) Manufactured upon receipt of order.

Antistatic Equipment

Antistatic Speed Controller AS-X260

Dimensions

Elbow type

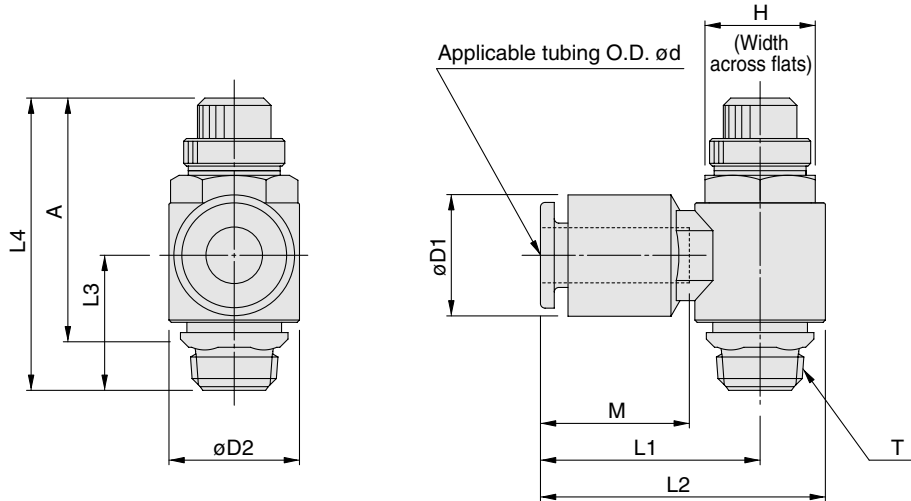

Model		Applicable tubing O.D. ød	T	H	D1	D2	L1	L2	L3	L4		A*)		M
Meter-out	Meter-in									MAX.	MIN.	MAX.	MIN.	
AS1201F-M5-04-X260	AS1211F-M5-04-X260	4	M5	8	10.4	9.6	20.6	25.4	12.2	28.8	26	25.2	22.4	15.8
AS1201F-M5-06-X260	AS1211F-M5-06-X260	6			12.8		26.4	16.8						
AS2201F-U01-04-X260	AS2211F-U01-04-X260	4	Uni1/8	12	11.4	14.2	23.1	30.2	14.3	36.4	31.4	31	26	15.8
AS2201F-U01-06-X260	AS2211F-U01-06-X260	6			13.2		31	16.8						
AS2201F-U01-08-X260	AS2211F-U01-08-X260	8			15.2		32.4	18.7						
AS2201F-U01-10-X260	AS2211F-U01-10-X260	10			18.5		39.2	20.8						
AS2201F-U02-04-X260	AS2211F-U02-04-X260	4	Uni1/4	17	10.4	18.5	25.2	34.4	17.2	39.6	34.6	33	28	15.8
AS2201F-U02-06-X260	AS2211F-U02-06-X260	6			12.8		36.4	16.8						
AS2201F-U02-08-X260	AS2211F-U02-08-X260	8			15.2		44.5	18.7						
AS2201F-U02-10-X260	AS2211F-U02-10-X260	10			18.5		47.8	20.8						

*)Reference thread dimensions after installation.

In-line type

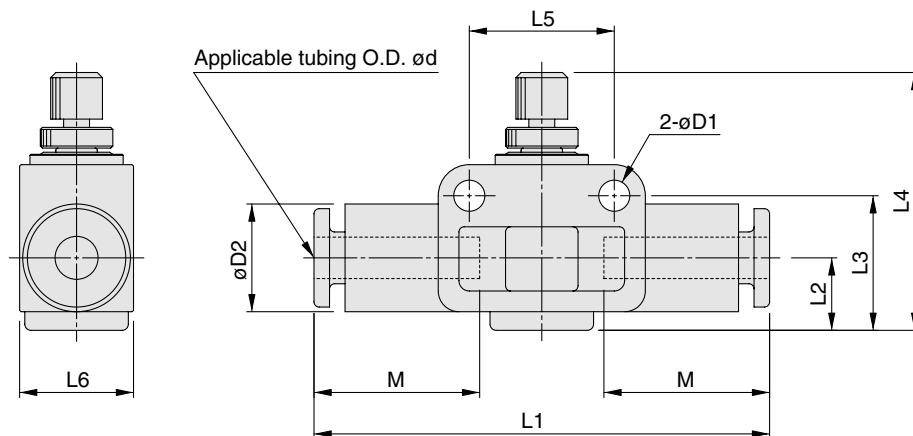







Model	Applicable tubing O.D. ød	D1	D2	L1	L2	L3	L4		L5	L6	M
							MAX.	MIN.			
AS1000F-04-X260	4	3.2	10.4	44	7	13	25	28	14	11	15.8
AS1000F-06-X260	6		12.8	46		13.5					16.8

















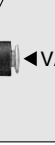

For the safe use of the controller, be sure to read "Safety Precautions" in our company's Best Pneumatics General Catalog before handling.

Vacuum Pad Series ZP

Pad material	● Conductive NBR (Black with one white mark), Conductive silicon rubber (Black with two white marks)
---------------------	--

Pad shape (Compatible with all models)	Flat (U) 	Flat with ribs (C) 	Deep (D) 	Bellows (B) 	Thin flat (UT) 	Thin with ribs (CT) 								
	Pad size	2 x 4	3.5 x 7	4 x 10	ø2	ø4	ø6	ø8	ø10	ø13	ø16	ø20	ø25	ø32
Flat	●	●	●	●	●	●	●	●	●	●	●	●	●	●
Flat with ribs	-	-	-	-	-	-	-	-	-	-	-	-	-	-
Deep	-	-	-	-	-	-	-	-	-	-	-	-	-	-
Bellows	-	-	-	-	-	●	●	●	●	●	●	●	●	●
Thin flat	-	-	-	-	-	-	-	-	-	-	-	-	-	-
Thin with ribs	-	-	-	-	-	-	-	-	●	●	●	-	-	-

Model	Without buffer		With buffer		Non-rotating / Rotating ø2 to 8: stroke 6, 10, 15, 25 mm ø10 to 32: stroke 10, 20, 30, 40, 50 mm ø40/50: stroke 10, 20, 30, 50 mm	
	Vacuum entry	Connection	Vacuum entry	Connection		
 Series ZPT Vertical vacuum entry	Male thread	(Common)		Female thread	Buffer body	
	Female thread	(Common)		With barb fitting	Buffer body	
				With one-touch fitting	Buffer body	
 Series ZPR Lateral vacuum entry with one-touch fitting	With one-touch fitting	Male thread		With one-touch fitting	Buffer body	
	With one-touch fitting	Female thread				
 Series ZPY Lateral vacuum entry with barb fitting	With barb fitting	Male thread		With barb fitting	Buffer body	
	With barb fitting	Female thread				

Vacuum Pad Made to Order

Antistatic Pad

With the use of antistatic urethane rubber, the pad can eliminate the static electricity more slowly compared to the conductive rubber. 10^9 to $10^{11} \Omega \cdot \text{cm}$

How to Order

INO — 3769 — 1968 — 10 C

Pad diameter	
10	ø10
Pad shape	
C	Flat with ribs
Pad material	
N	NBR
S	Silicon rubber
U	Urethane rubber
U1	Antistatic urethane rubber
F	Fluoro rubber
GN	Conductive NBR
GS	Conductive silicon rubber
Specifications	
G	Pad only
Nil	Pad with lock ring

Dimensions

(mm)

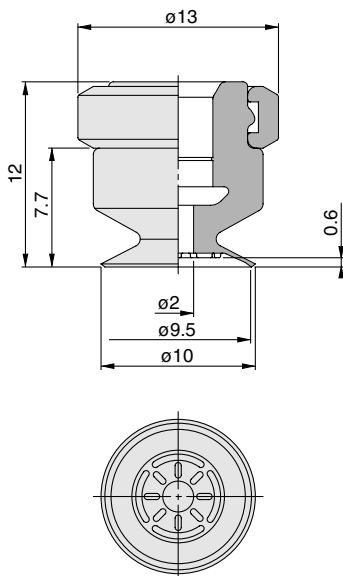

* Interchangeable with standard (ø10 to ø16) adapter.

How to Order

INO — 3769 — 1561

Pad Part Number

INO — 3769 — 1369 — G

Rubber Specifications

Material	Antistatic urethane rubber
Volume resistivity value	10^9 to $10^{11} \Omega \cdot \text{cm}$
Durometer	80±5

Dimensions

(mm)

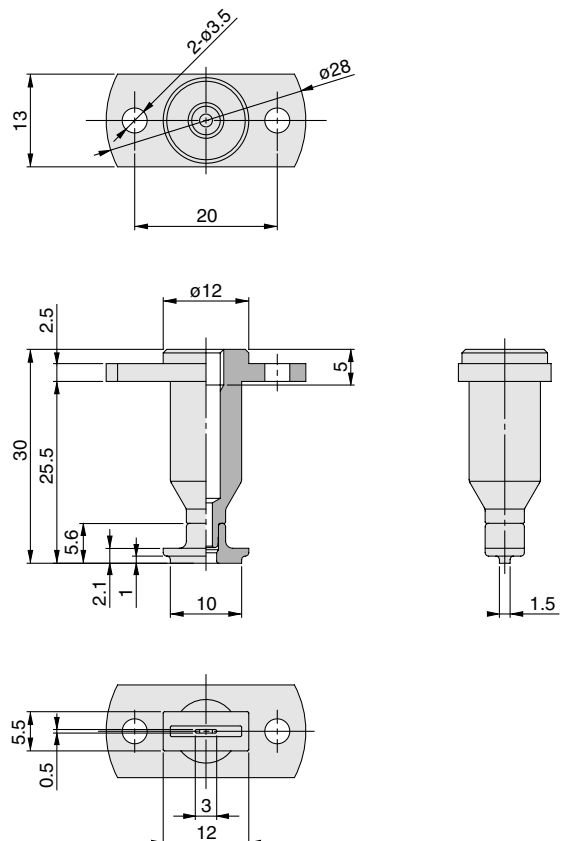

Metal Pad with Buffer

- Improved accuracy for suction point.
- Impact to the work is reduced by buffer.
- Prevent detachment failure due to static electricity, and avoid work damage.
- As metal is used for rubber end, static electricity can be instantly eliminated.



How to Order

ZP – A0035XTJAC – DBJ00315

Dimensions

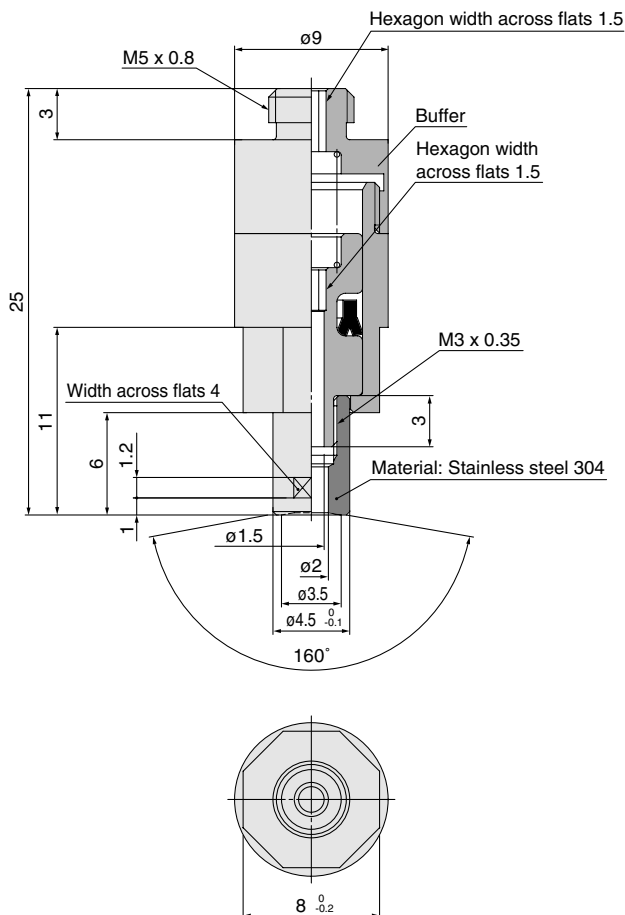

Buffer Specifications

Rotation stopper	None
Stroke	2 mm

If glue is not applied to the threads the screw may become loose.

- When you need buffer only, use the following part numbers to order.
 - Buffer part number ①: **ZP-CZZZ9ZJAC-DBJ00315**

Sponge Pad

- Conductive silicon and conductive CR are adopted.
- Applicable to BGA ball surface, electric substrate, uneven work surface
- Rubber is used for the adapter end surface to reduce impact when contacting the work.



How to Order

INO – 3769 – 2450 – SG 06

Specifications
SG Sponge 0

Dimensions

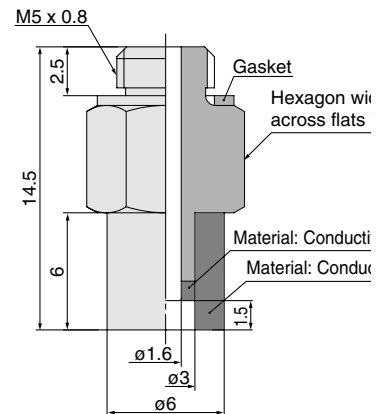

- When you need sponge or adapter only, use the following part numbers to order.
 - Sponge part number: **INO-3769-2380-G**
 - Adapter part number: **INO-3769-2450-A**

How to Order

INO – 3769 – 2665 – SG 10

Specifications
SG Sponge 1

Dimensions

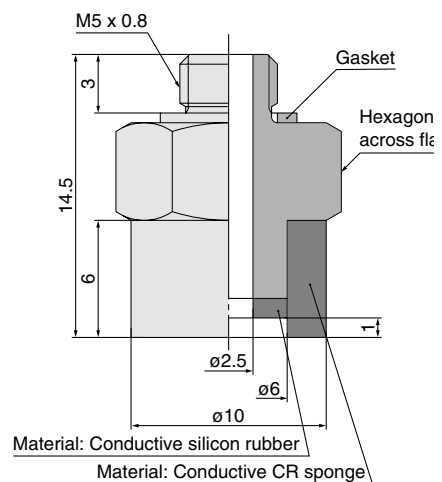

- When you need sponge or adapter only, use the following part numbers to order.
 - Sponge part number: **INO-3769-1839-S10-G**
 - Adapter part number: **INO-3769-2665-AD**

Clean Attachment for Vacuum Pad / ZP-E20□-DBH00142

Made to Order

With the use of conductive PEEK material attachment on the bellows rubber pad, static electricity can be prevented, and oil will not be left on the work.

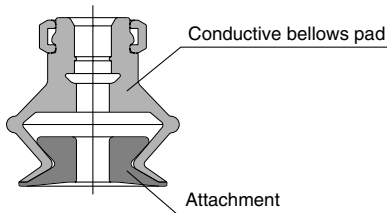

- Prevent the work from contacting the rubber material, and stop transition of the oil oozing out of the rubber material. (Note: Please consult SMC for details.)
- With combination with bellows pad, scratches on the work can be decreased.
- Applications: Suction process of semiconductor and FPD devices

Variations

Size	ø6, ø8, ø10, ø13, ø16, ø20, ø25, ø32
Material	Conductive PEEK (Volume resistivity: 10 ⁵ to 10 ⁶ Ω·cm)
Applicable pad	Bellows vacuum pad

Attachment



Standard pad diameter	Conductive PEEK
ø6	ZP-E201-DBH00142
ø8	ZP-E202-DBH00142
ø10	ZP-E203-DBH00142
ø13	ZP-E204-DBH00142
ø16	ZP-E205-DBH00142
ø20	ZP-E206-DBH00142
ø25	ZP-E207-DBH00142
ø32	ZP-E208-DBH00142

Note) Part number in above table shows the number for the attachment only. If pad is ordered together, please refer followings.

How to Order (attachment and pad together)

- As shown below, add * for the attachment part number beneath the vacuum pad number. But please note that they are not assembled.
- This attachment can be mounted to SMC standard bellows pad only.
- For conductive PEEK attachment, use the pad made of conductive material.

Ex. ZPT06B9NJ10-B5-A8 ← Vacuum pad part number
 * ZP-E201-DBH00142 ← Attachment part number

Dimensions

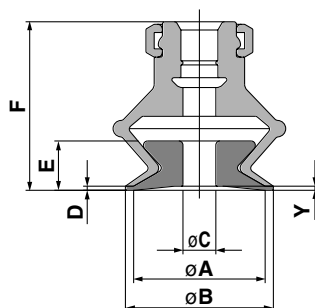

Model	A	B	C	D	E	F
ZP06B	6	7	1.6	0.5	3	13.5
ZP08B	8	9	3			
ZP10B	10	12	3.5		5.5	19
ZP13B	13	15	4			
ZP16B	16	18	8	1	8.5	24.5
ZP20B	20	22				
ZP25B	25	27				
ZP32B	32	34	10		11.5	30

<Caution>

- Clean the attachment before usage.

This product is not cleaned after machining. Do not use the attachment out of the package, or residual subject attachment is transferred to the work.

Please consult SMC if any question occurs.

Cleaning method (Reference)

- 1) Use vinyl gloves which do not generate particle, and hold the pad except vacuuming part.
- 2) Supply 2-Propanol (isopropyl alcohol) for electronic industry (Purity > 99.5%) to a cloth which does not generate particle.
- 3) Wipe lightly the attachment vacuum surface and the part which may contact with the work.
- 4) Wipe it again with a dry cloth which generates no particle.

- If the contact with hard material becomes a problem, do not use the attachment.



Removing the film covering the contacting foot brackets (anodization), causes the cylinder to become conductive from the piston rod end to the foot brackets.

How to Order

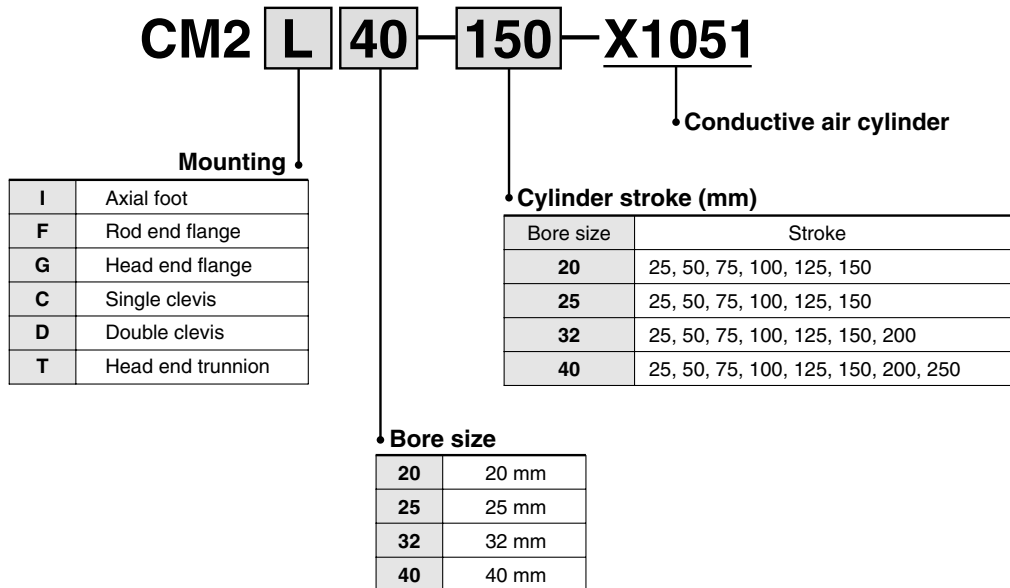

It is possible to eliminate static electricity from the mounted brackets without moving the ground wire attached to the flexible part.

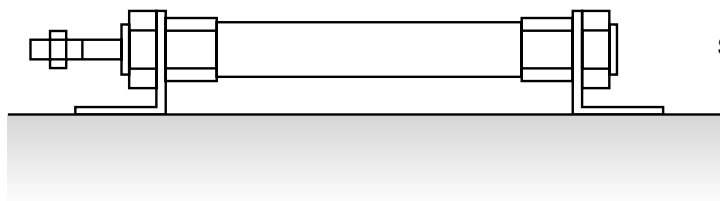

Surface resistance value: $10^{-1} \Omega$ or less

Electrostatic Removal Equipment (10)

Electrostatic removal equipment generate ions by corona discharge to eliminate (neutralize) static electricity.

An ionizer is useful under the following conditions:

- Grounding is not possible.
- Humidity levels cannot be controlled.
- Workpiece comprises insulated materials such as rubber.
- Conductive materials cannot be applied.

Electrostatic removal equipment generate positive or negative ions by utilizing corona discharge etc. Ions sent to the workpiece adjust the ion balance of positively or negatively charged workpieces, making them electrically balanced and eliminating static electricity.

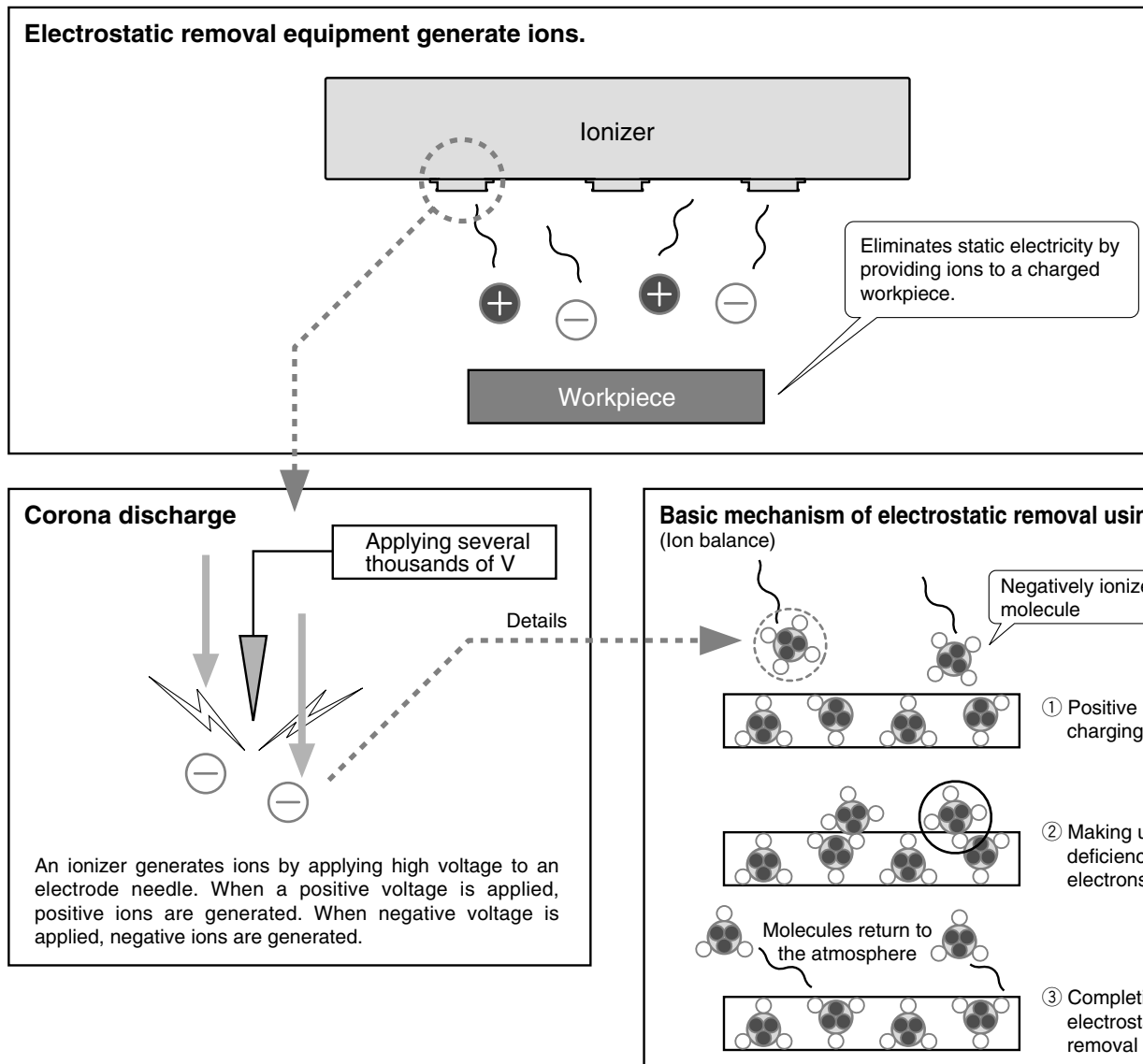

Ionizer Series IZS31

● Discharge time **0.3** seconds

Discharge time was reduced by improving the efficiency of the basic specifications for the feedback sensor, air purge pressure, and high frequency etc.

Conditions / Static buildup decreased from 1000 V to 100 V
 Discharged object: Charged plate monitor (150 mm x 150 mm, capacitance 20 pF)
 Installation distance: 200 mm
 (Tungsten electrode with air purge)



Auto-balance sensor

Measures the ion balance.



Feedback sensor

Detects the polarity of a discharged object and measures the charged voltage.

Rapid elimination of static electricity using a feedback sensor

- The speed of static electricity removal has been increased by reading the workpiece's electrostatic potential with the feedback sensor and continuously emitting ions of a reverse polarity.

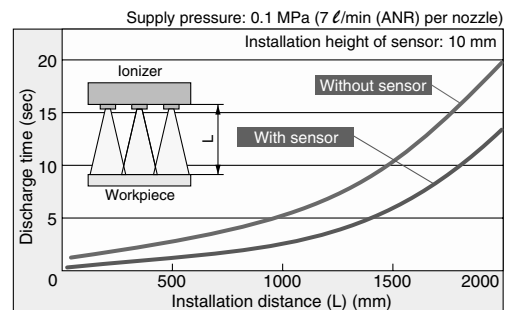
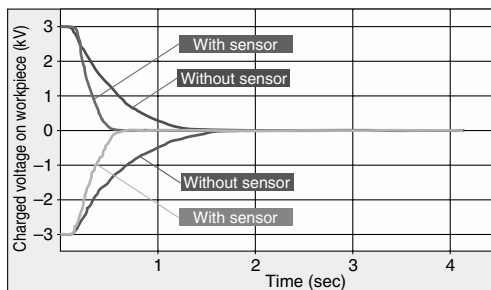

- Operation mode after static electricity removal (ion balance: within ± 30 V) can be selected.

Energy saving run mode: Stops generating ions after static electricity removal to reduce power consumption.

Air consumption can also be reduced by controlling the pneumatic valve with a static electricity removal completion signal.

(Note) The pneumatic valve must separately be procured.

Continuous static electricity removal run mode: After static electricity removal, the ionizer changes to pulse DC operation and continues to remove static electricity to make it approach 0 V even if the ion balance is below 30 V.

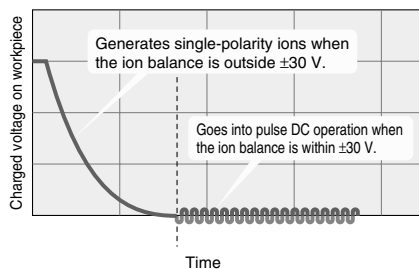

Mode	Ion emission waveform
Sensing DC Energy saving run	+ Stop - Stop
Sensing DC Continuous static electricity removal run	+ Pulse - Pulse
Pulse DC	+ Pulse - Pulse
+ charged image	+ Pulse - Pulse Static electricity removal completed

Automatic ion balance adjustment and **reduction** in ion balance **adjustment** man-hours using an auto-balance sensor

- In the pulse DC mode, the ion balance can be automatically adjusted using an auto-balance sensor.

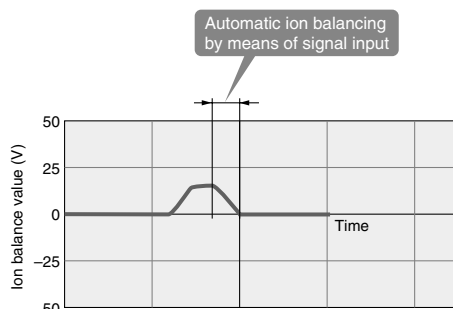

- The auto-balance sensor may be connected only when adjusting the ion balance.

- The object is not affected by the height of installation or any disturbance interference since the ionizer is designed to adjust the ion balance near the auto-balance sensor.

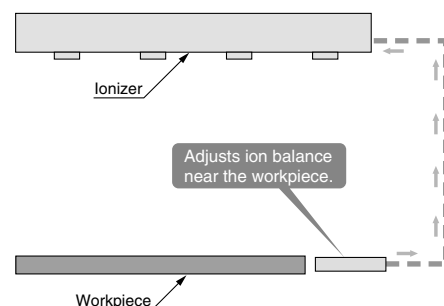

Available for workpieces **moving at high speed**

- Switching over frequency: **Max 60 Hz**

Ions are discharged at high density at workpieces moving at high speed.

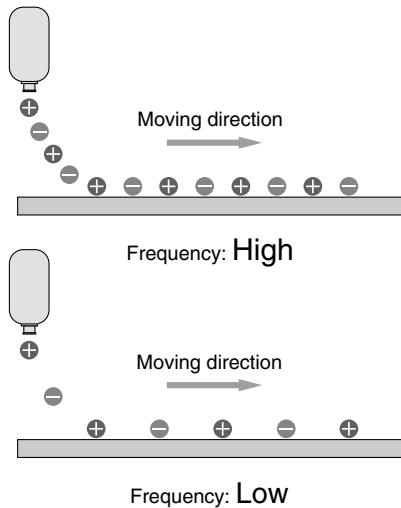

This reduces the range of surface potential fluctuations for short installation distances after static electricity removal.

Note) The range of surface potential fluctuations varies depending on the object's material, etc.

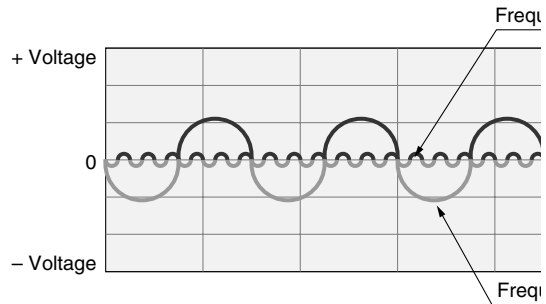

Effective for **short range static electricity elimination**

- Electricity removal variation prevented

Electrode cartridge 40 mm pitch: **-X15**

(Standard: 80 mm pitch) (Supported length: 1260 mm max.)

Note) Air purge nozzles are arranged at an 80 mm pitch.

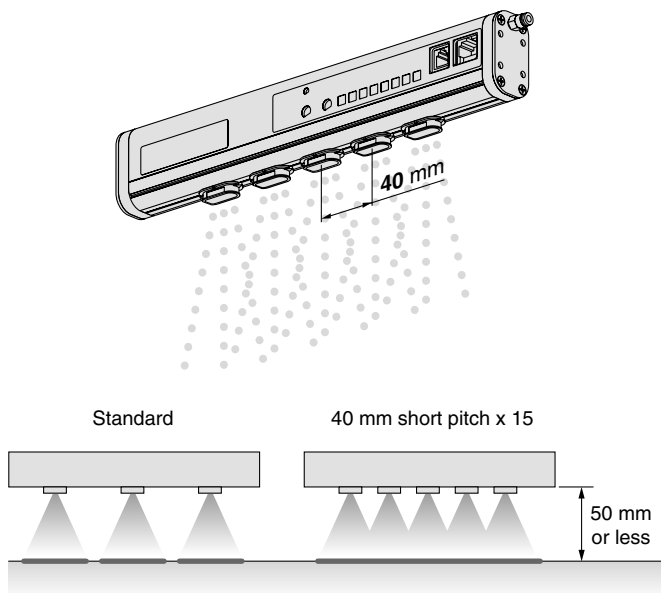

Applicable for air purge supply pressure: **0**

- Effective for removal of foreign matter during range elimination of static electricity

Air purge: Yes With sensor: (1 Hz/60 Hz)

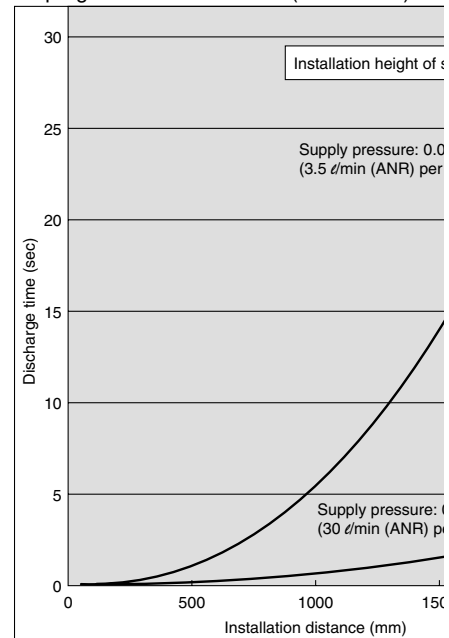

DC mode: According to the setting of the frequency trimmer, **any polarity can be fixed** for consecutive emission.

- Can be used to eliminate static electricity from high speed, high electric potential workpieces.

Display function

- Visualization of charging condition (During sensing DC mode)
- Visualization of ion balance (When pulse DC mode or auto-balance sensor are used.)

Workpiece electric polarity	LED + OK -	Workpiece electric charge voltage	
Positive ↑ Static electricity removal completed	■ ■ ■ ■	+400 V or higher	■ Light ON
	■ ■ ■ ■	+100 V to +400 V	■ Blinking at 4 Hz
	■ ■ ■ ■	+30 V to +100 V	■ Light OFF
↓ Negative	■ ■ ■ ■	Within ±30 V	
	■ ■ ■ ■	-30 V to -100 V	
	■ ■ ■ ■	-100 V to -400 V	
	■ ■ ■ ■	-400 V or lower	



Detects electrode needle stain upon signal input

Light ON: ±30 V or less
Blinking: Approx. ±30
Light OFF + Alarm output: Unadjustable

Detects the electric potential difference and outputs in an analog voltage. (During sensing DC mode)

- Outputs measured data at a 1 to 5 V level when a feedback sensor is used. By outputting the data to a PLC, etc., it is possible to control static electricity.

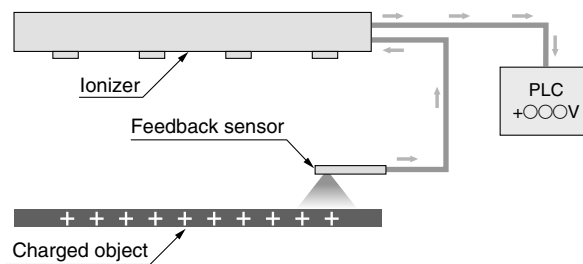

Option

- 3 types electrode needle material
 - Tungsten (Ion balance: ±30 V)
 - Monocrystal silicon (Ion balance: ±30 V Applicable to environments sensitive to metal contamination)
 - Stainless steel (Ion balance: ±100 V)



- Non-standard bar length compliant: IZS31-□□□-X10 (Made to Order)

Standard	300, 380, 620, 780, 1100, 1260, 1500, 1900, 2300
-X10	460, 540, 700, 860, 940, 1020, 1180, 1340, 1420, 1580, 1660, 1740, 1820, 1980, 2060, 2140, 2220

Safety function

- Electrode cartridge drop prevention
 - Locking by double-action

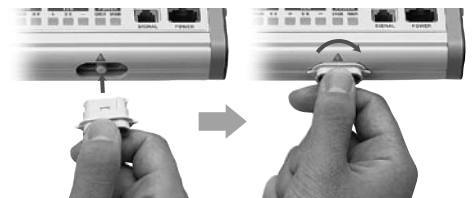

- Security cover
 - Can even more reliably prevent electrode cartridges from dropping off.



Examples of Applications

Eliminating static electricity on PET bottles

- Trip-resistance during conveying.
- Prevents adhesion of dust.

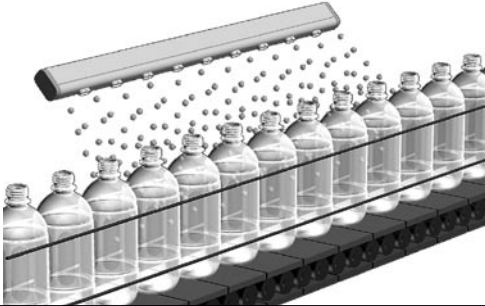

Eliminating static electricity on a film

- Prevents adhesion of dust.
- Prevents winding failure due to wrinkles, etc.

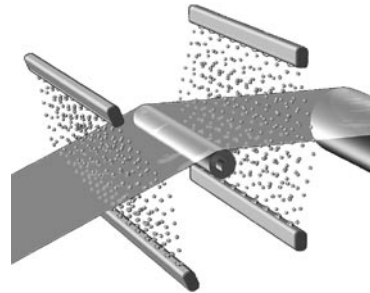

Eliminating static electricity on mold goods

- Improves detachability of mold goods from a die.

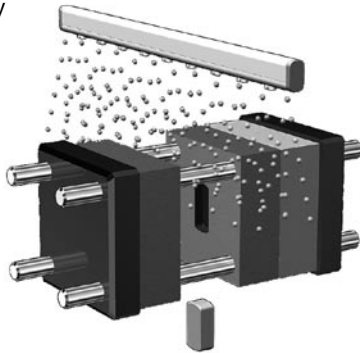

Eliminating static electricity on film mold g

- Prevents attaching to conveyer.
- Prevents dispersion of finished goods.

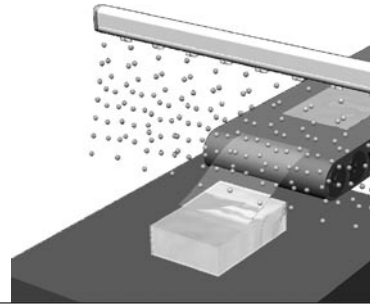

Eliminating static electricity wafer transfer

- Prevents breakage due to discharge between wafers and hands.

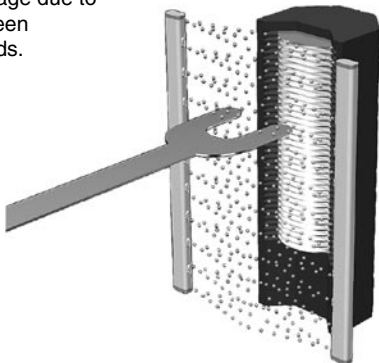

Removal of static electricity from packing films

- Prevents the filled substance from adhering to the packing film.
- Reduces packing mistakes.



Eliminating static electricity on an electric substrate

- Prevents element disruption due to discharge.
- Prevents adhesion of dust.

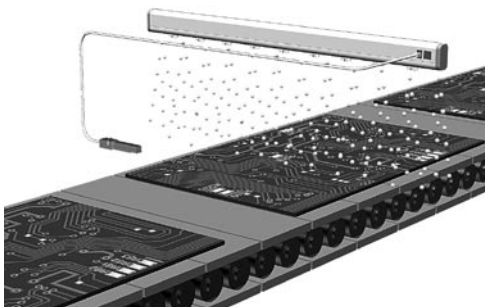

Eliminating static electricity on a glass sub

- Prevents breakage due to adhesion and discharge.
- Prevents adhesion of dust.

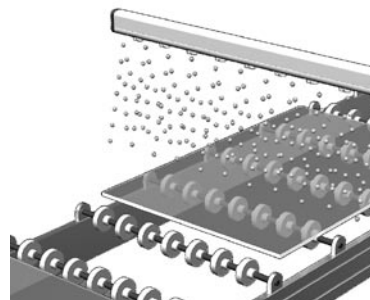

Electrostatic Removal Equipment

Ionizer Series IZS31

Specifications

ionizer model		IZS31-□□ (NPN specification)	IZS31-□□P (PNP specification)
Ion generation method		Corona discharge type	
Method of applying voltage		Sensing DC, Pulse DC, DC	
Output for emitting electricity		±7000 V	
Ion balance <small>Note 1)</small>		±30 V (Stainless electrode needle: ±100 V)	
Air purge	Operating pressure	0.7 MPa or less	
Power supply voltage		24 VDC ±10%	
Effective discharge distance		50 to 2000 mm (Sensing DC mode: 200 to 2000 mm)	

Note 1) In case where air purge is performed between a charged object and an ionizer at a distance of 300 mm.

How to Order

Ionizer **IZS31-780** □□ □□ □□ □□ □□ □□ □□ □□ □□

● **Bar type**
● **Bar length**

Symbol	Bar length
300	300 mm
380	380 mm
620	620 mm
780	780 mm
1100	1100 mm
1260	1260 mm
1500	1500 mm
1900	1900 mm
2300	2300 mm

● **Electrode needle material**

Nil	Tungsten
C	Silicon
S	Stainless steel

● **Output**

Nil	NPN output
P	PNP output

● **Power supply cable**

Nil	With power supply cable (3 m)
Z	With power supply cable (10 m)
N	None

● **Made to Order**
Refer to the below table.

● **Sensor**

Nil	None
F	With feedback sensor
G	With auto-balance sensor

● **Bracket**
(End bracket, Center bracket)

Nil	None
B	With bracket <small>Note)</small>

Note) The number of center brackets differ depending on the bar length. (Refer to the below table.)

Number of Brackets

Bar length (mm)	End bracket	Center bracket
300, 380, 620, 780	With 2 pcs.	None
1100, 1260, 1500		With 1 pc.
1900, 2300		With 2 pcs.

Made to Order

Ionizer / Series IZS31

Symbol	Contents	Specifications
-X10	Non-standard bar length compliant (80 mm pitch)	460, 540, 700, 860, 940, 1020, 1180, 1340, 1420, 1580, 1660, 1740, 1820, 1980, 2060, 2140, 2220
-X14	Model with electrode cartridge security cover	The main unit is shipped fitted with an electrode cartridge security cover available as an option.
-X15	Model with 40 mm pitch electrode cartridges	This model comes fitted with electrode cartridges arranged at a 40 mm pitch (standard pitch: 80 mm). Note) Maximum bar length is 1260 mm. The air purge nozzles are arranged at an 80 mm pitch.

Refer to the catalog ES100-68 for details.

Related Static Electricity Eliminating Equipment

SMC can provide all the equipment required to supply air to the ionizer.

Consider the equipment below not only for providing an “opportunity to decrease maintenance” but also for an “energy-saving countermeasure”.

Recommended pneumatic circuit diagram

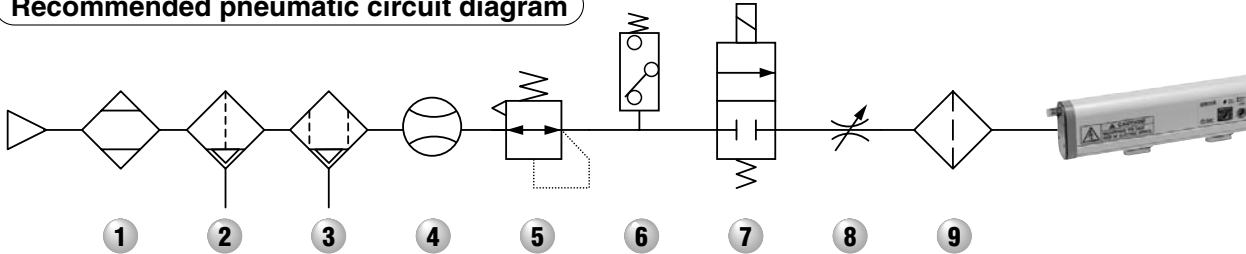

1 Air Dryer / Series IDF

Decreases the dew point of compressed air. Limits moisture generation which can lead to damage.



2 Air Filter / Series AF

Eliminates solid foreign matters such as power particles in the compressed air.



3 Mist Separator / Series

Eliminates oil mist which is eliminated with an air filter.



4 Digital Flow Switch / Series PF2A

Decreases the air consumption by flow control.



2-Color Display Digital Flow Switch / Series PFM



5 Regulator / Series AR

Decreases the air consumption to an appropriate pressure.



6 Digital Pressure Switch / Series ISE30

The pressure control prevents the ability of static electricity removal from being reduced in accordance with the reduction of air pressure.



7 2 Port Solenoid Valve / Series VX



8 Throttle Valve / AS-X2

Regulates to the appropriate a depending upon the installation. Decreases the air consumption.



9 Clean Air Filter / Series SFD

Built-in hollow fiber elements Filtration: 0.01μm. Adopted hollow fiber elements with over 99.99% filtering efficiency don't contaminate workpieces.



Measurement Equipment

Confirmation of “actual status” is important in controlling static electricity.

- **Potential measurement: ± 20 kV** (detected at a 50 mm distance)
 ± 0.4 kV (detected at a 25 mm distance)
- **Detects the electrostatic potential and outputs in an analog voltage.**
 - Output voltage: 1 to 5 V (output impedance: Approx. 100 Ω)
- **Possible to measure electrostatic potential**

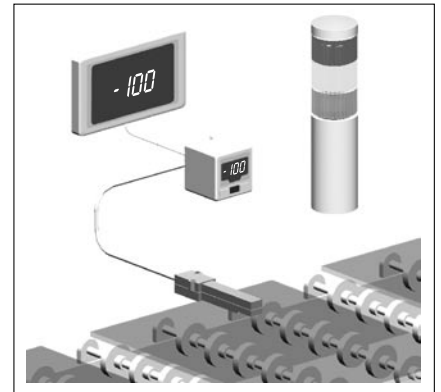

Electrostatic Sensor Series IZD10

Dimensions (actual size)

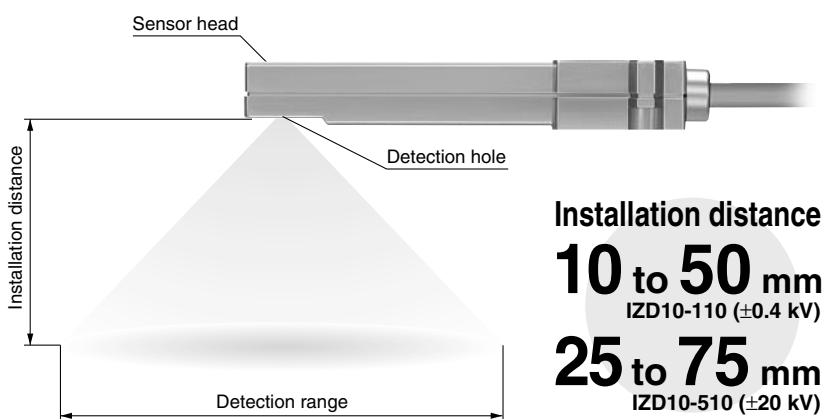
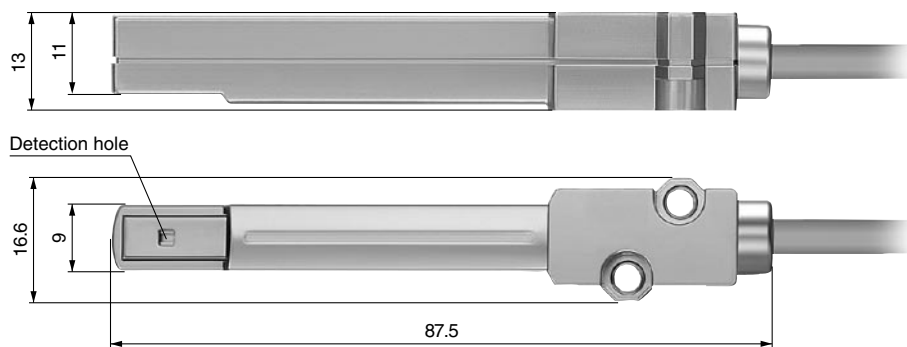

Installation Distance and Detection Range

IZD10-110		IZD10-510	
Installation distance (mm)	Detection range (mm)	Installation distance (mm)	Detection range (mm)
10	45	25	100
20	85	30	120
25	100	40	150
30	120	50	180
40	150	60	205
50	180	70	225
		75	235

How to Order

IZD 10 - 1 10

Model

10 Electrostatic sensor

Potential measurement

1 ± 0.4 kV
5 ± 20 kV

Electrostatic Sensor Monitor Series IZE11

- Output: Switch output x 2 + Analog output (1 to 5 V, 4 to 20 mA)
- Minimum unit setting: 0.001 kV (at 0.4 kV), 0.1 kV (at 20 kV)
- Display accuracy : $\pm 0.5\%$ F.S. ± 1 digit or less
- Detection distance correction function (adjustable in 1 mm increments)
- Range switching supports two sensors. (± 0.4 kV, ± 20 kV)



Electrostatic Sensor
Ser

How to Order

IZE11 0

Output specifications

0	NPN open collector 2 outputs + Analog output (1-5 V)
1	NPN open collector 2 outputs + Analog output (4-20 mA)
2	PNP open collector 2 outputs + Analog output (1-5 V)
3	PNP open collector 2 outputs + Analog output (4-20 mA)

Option 1

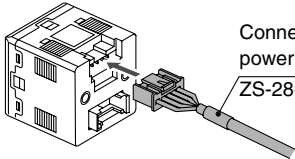
Nil	None
L	Connector cable for power supply / output  Connector cable for power supply / output ZS-28-A

Note) The cable is not connected but packed together with product for shipment.

Option 3

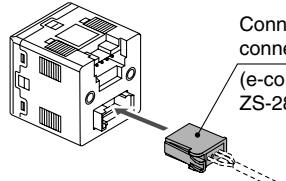
Nil	None
C	With connector for sensor connection  Connector for connection (e-con connec ZS-28-C)

Note) The connector is not connected but packed together for shipment.

Option 2

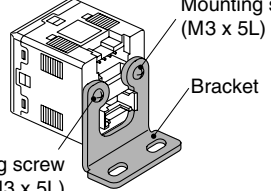
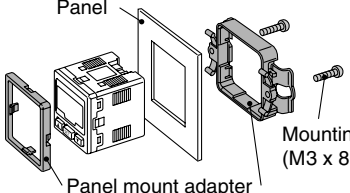
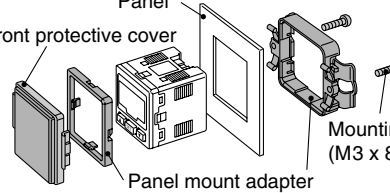
Nil	None
A	Bracket  Mounting screw (M3 x 5L) Bracket
B	Panel mount adapter  Panel Mounting (M3 x 8L) Panel mount adapter
D	Panel mount adapter + Front protective cover  Panel Front protective cover Mounting (M3 x 8L) Panel mount adapter

Note) The options are not attached but packed together with product for shipment.

Options / Part No.

Description	Part no.	Note
Connector cable for power supply / output (2 m)	ZS-28-A	
Bracket	ZS-28-B	With M3 x 5L (2 pcs.)
Connector for sensor connection	ZS-28-C	1 pc.
Panel mount adapter	ZS-27-C	With M3 x 8L (2 pcs.)
Panel mount adapter + Front protective cover	ZS-27-D	With M3 x 8L (2 pcs.)

Handheld Electrostatic Meter

Series IZH10

Measurement Equipment

Handheld Electrostatic Meter Series IZH10

Confirmation of “actual status” is important in controlling static electricity.
Easy-to-use handheld electrostatic meter

- Measuring range: ± 20.0 kV
- Minimum display unit: **0.1 kV** (± 1.0 to ± 20.0 kV)
0.01 kV (0 to ± 0.99 kV)
- Compact and Lightweight: 85 g (excluding dry cell batteries)
- Backlight for reading in the dark
- LOW battery indicator
- Peak & Bottom display function
- Zero-out function
- Auto power-off function



How to Order

IZH 10 -

● Option

Nil	None
H	High voltage measuring handle

Accessories and Options / Part Numbers for Individual Parts

* The ground wire and soft case are attached to the IZH series.

Ground wire (1.5 m) / Accessories
IZH-A-01

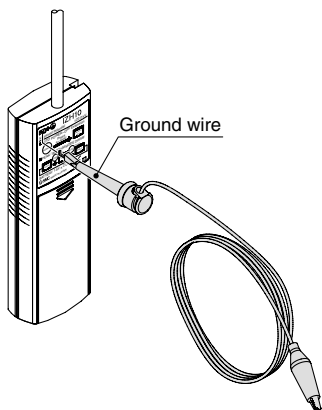

Soft case / Accessories
IZH-B-01

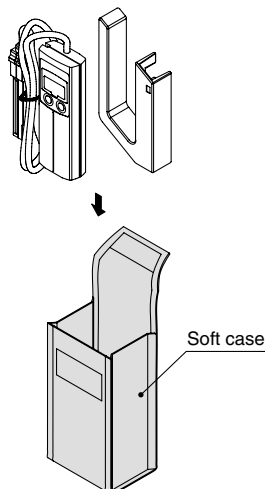

High voltage measuring handle / Option
IZH-C-01

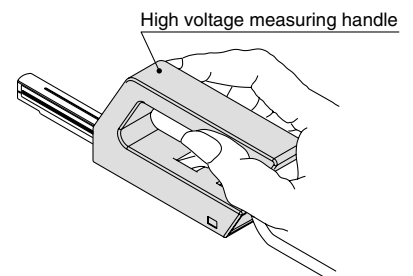



Technical Information

1. Types of Static Electricity Generation

There are various types and names of static electric generation. Basically, static electricity is generated when objects come into contact with one another or when they are separated.

Contact Charging

Static electricity generated when two objects come into contact.

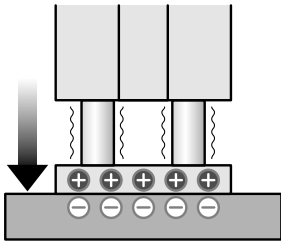

Separation Charging

Static electricity that occurs when two objects that were in contact with each other are separated.

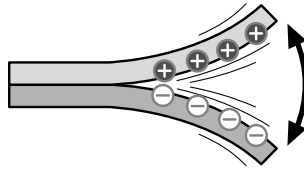

Frictional Charging

Static electricity generates when two objects are rubbed together.

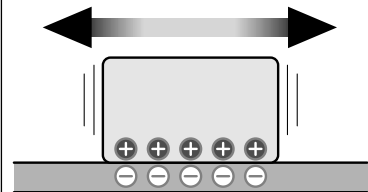

Clash Charging

Static electricity generated when objects (particles or the like) collide with strong impact.

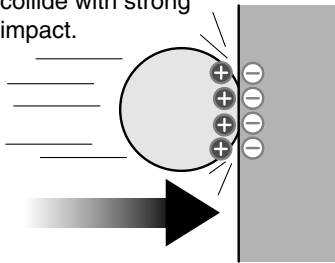

Vapor Charging

Static electricity generates in liquid when water coming out of nozzle becomes misty.

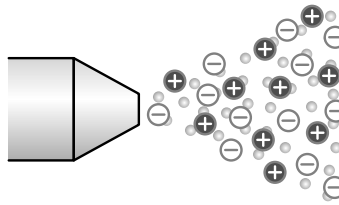

Rolling Charging

Static electricity generated when objects roll over other objects.

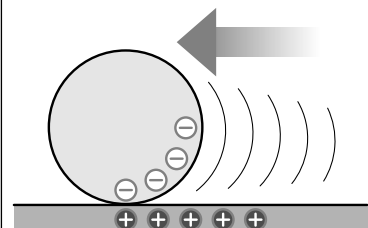

Induction Charging

When an electro-statically charged object approaches another object, static electricity occurs on the opposite side of that object.

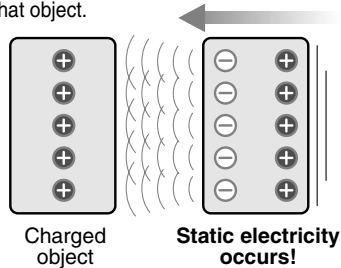

Charging from External Ion

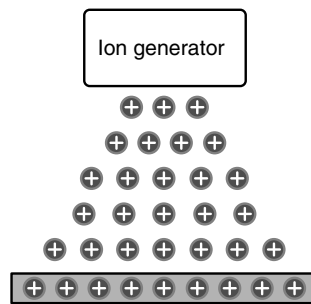

2. Static Electricity

● Why is static electricity generated?

① Principle of static electricity

When looking closely, you can see that all matter is composed of **atoms**. An atom has **protons and electrons that are in electrical balance**. Electrons may become separated from or attached to the atom with a small force.

Disruption of the **balance between protons and electrons leads to static electricity**.

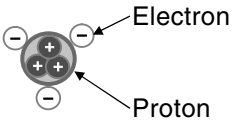
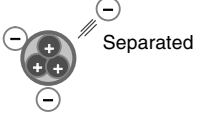
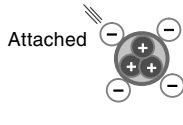
No static electricity (0 V)	Positively charged (+)	Negatively charged (-)
 <p>Electron</p> <p>Proton</p>	 <p>Separated</p>	 <p>Attached</p>
Protons (+) and electrons (-) are balanced and no static electricity is generated.	When an electron (-) separates from the atom, the number of protons (+) exceeds the number of electrons (-), resulting in a positively charged state.	When an electron (-) attaches to an atom, the number of electrons (-) exceeds that of protons (+), resulting in a negatively charged state.

Note) 3 electrons are mentioned in the figure, but the number of electrons varies depending on the atom.

● Causes of generating static electricity

① Contact charging

When 2 objects come in contact with each other, electrons can move between the objects. When the objects are suddenly separated under this condition, the atoms are polarized and static electricity is generated.

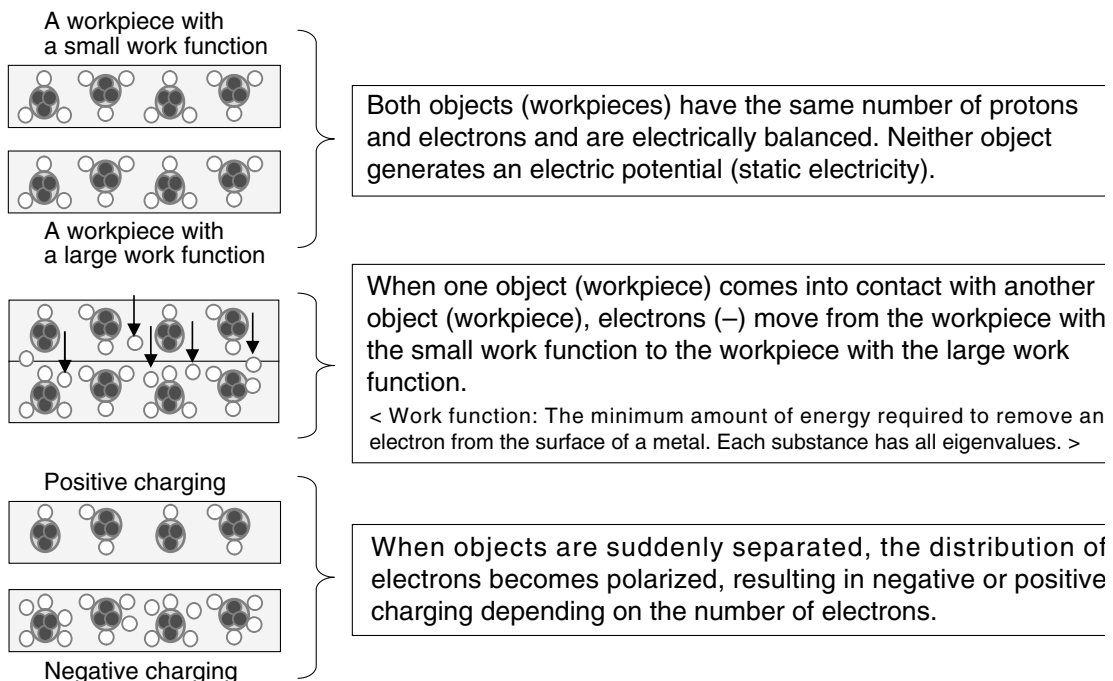

Electric Polarity and the Amount of Electric Charge

● Triboelectric series

The “electric polarity” and “amount of electric charge” when 2 objects come into contact with each other, are shown in the **triboelectric series**.



Human body
Glass
Mica
Nylon
Wool
Silk
Aluminum
Polyester
Paper
Cotton
Steel
Copper
Rubber
Polyurethane
Polypropylene
Vinyl chloride
Silicon
Fluororesin

How to read the triboelectric series

1: Electric polarity

The materials mentioned in the upper part of the triboelectric series are charged positively and those mentioned in the lower part are charged negatively.

Example 1: Glass (+) Polyester (-)

Example 2: Polyester (+) Fluororesin (-)

2: Electric charge

As the distance between 2 materials becomes greater, the amount of charge becomes larger.

Example 1: Amount of charge between the human body and nylon (Small)

Example 2: Amount of charge between the human body and polyurethane (Large)

② Induction charging

Induction charging is static electricity that is generated when a charged object gets close to another object without contacting it. This static electricity is difficult to detect because the objects do not come into contact with each other.

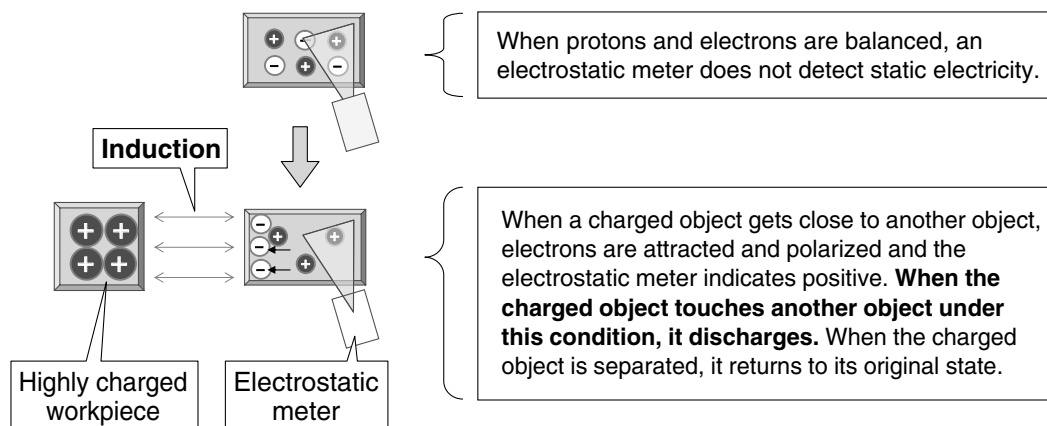

Static Electricity (continue)

Examples of Failures due to Induction Charging

● Device Breakdown 1

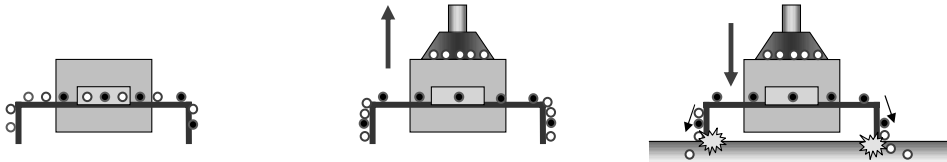

1) An uncharged device has no electrical polarization.

2) When a vacuum pad that has been charged due to repeated operations gets close to the device, static induction occurs. This figure shows that electrons move toward the electrode: the chip and its surroundings are positively charged.

3) When the device is mounted on a circuit board, electrostatic discharge occurs. In this case, a **conductive rubber pad** needs to be used.

● Device Breakdown 2

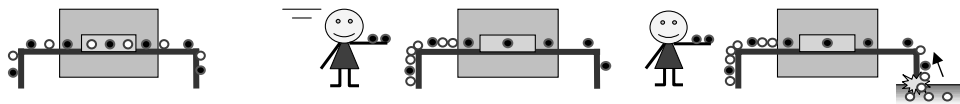

1) An uncharged device has no electrical polarization.

2) When an operator gets close to the device, induction charging occurs. The operator side of the device is negatively charged and the other side is positively charged.

3) When the device is grounded under this condition, static electricity is discharged. Electrons (-) flow into the device from the ground.

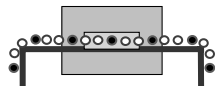

4) If the device is insulated, it becomes negatively charged when the operator leaves the device due to the remaining electrons.

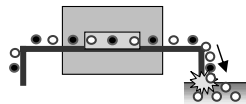

5) When the device is once again grounded, electrostatic discharge occurs again. Electrons (-) flow out.

● Ion charging

Equipment using ultraviolet light etc. may generate ions.
When those ions become attached to workpieces, workpieces become charged.

What is an ion?

- An ion is an electrically charged atom or molecule.
- The ionizer positively or negatively ionizes molecular oxygen (oxygen atoms) and molecular nitrogen (nitrogen atoms) in the air.

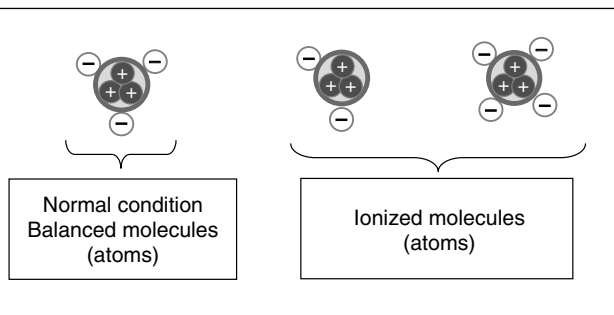

3. Countermeasures against Static Electricity

● Prevents static electricity from being generated.

- ① **Proper selection of materials that come into contact with each other (Utilizing the triboelectric series)**
- ② **Reduction of the contact area**
Generation of static electricity increases as the contact area increases. Equipment designs with less contact area are required.
- ③ **Reduction in the frequency with which objects come into contact with each other**
Static electricity accumulates when objects come into contact with each other repeatedly. Reduce the frequency with which objects come into contact with each other to reduce the generation of static electricity.
- ④ **Control of capacitance**
Static electricity voltage fluctuates with capacitance. Capacitance needs to be controlled to prevent static electricity from increasing unnecessarily.

Static electricity voltage and capacitance

● Static electricity voltage

Static electricity voltage can be calculated using the formula below.

$$\text{Voltage (V)} = \text{Quantity of Electric Charge (Q)} / \text{Capacitance (C)}$$

When the quantity of electric charge is constant, the voltage fluctuates with capacitance.

Example: When capacitance decreases, voltage increases.

● Capacitance (C)

The capacity to store static electricity between two objects. The capacitance between flat plates increases in proportion to the area (S) and decreases when the distance between the flat plates becomes larger.

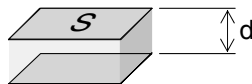

Example: The static electricity voltage of a workpiece on the table increases when the workpiece is lifted up because the capacitance becomes smaller.

● Prevent objects from being charged with static electricity.

Even if static electricity is generated, prevent objects from being charged to the extent that problems may result. Appropriate measures need to be taken, depending on the applications.

① Grounding

Grounding is a fundamental countermeasure against static electric. However, grounding is sometimes not complete due to insulation from lubricating oils, and that grounding is not deep enough in the ground, therefore, it is necessary to confirm the grounding.

② Humidity control

Humidity is controlled by humidifiers and such.

Caution: Humidifiers may not be effective for devices that obtain a high temperature.

③ Conductive products

Caution: Conductive products cannot discharge static electricity without grounding.

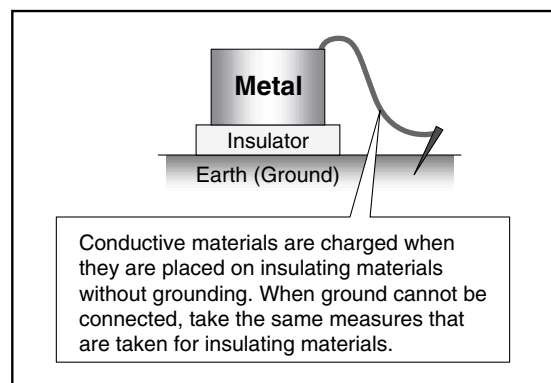

④ Removing static electricity with ionizers, etc.

● Difference in materials

Conductive materials

Conductive materials can discharge static electricity immediately with grounding. When surface treatments such as anodization and the like are applied, conductive materials will become insulated and grounding will be ineffective.

Insulated materials

Insulated materials cannot discharge static electricity even if they are grounded. To discharge static electricity, switch to using conductive materials, use humidity control or a surface active agent, or install an ionizers, etc.

● Electrostatic features of conductive and insulated materials

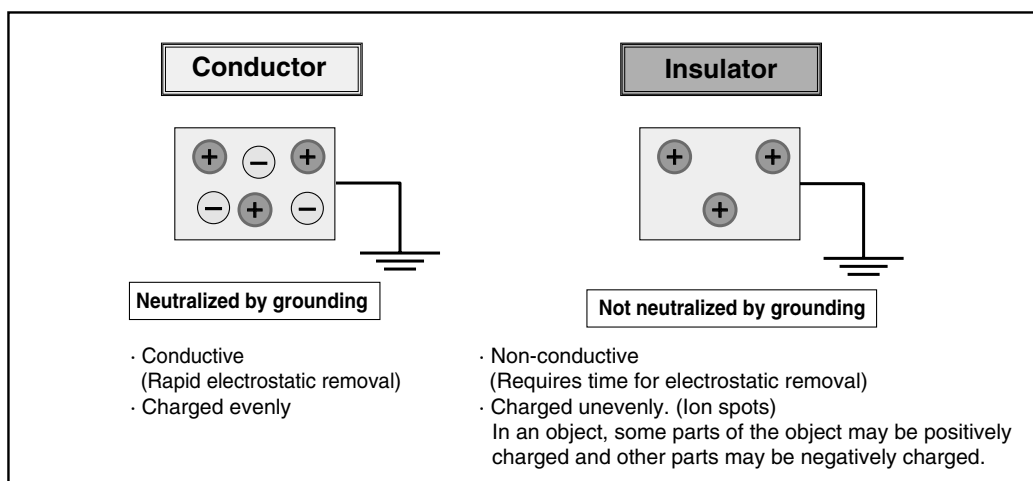



SMC Corporation

Akihabara UDX 15F,
4-14-1, Sotokanda, Chiyoda-ku, Tokyo 101-0021, JAPAN
Phone: 03-5207-8249 FAX: 03-5298-5362
URL <http://www.smcworld.com>
© 2007 SMC Corporation All Rights Reserved

Specifications are subject to change without prior notice
and any obligation on the part of the manufacturer.



D-KS

1st printing LW printing LW 13500KS - Printed in Japan.

This catalog is printed on recycled paper with concern for the global environment.